

**SUBJECT TO PROTECTIVE ORDER  
PUBLIC VERSION**

**UNITED STATES INTERNATIONAL TRADE COMMISSION  
Washington, D.C.**

**In the Matter of**

**CERTAIN POLYCRYSTALLINE  
DIAMOND COMPACTS AND  
ARTICLES CONTAINING SAME**

**Investigation No. 337-TA-1236**

**COMMISSION OPINION**

**Table of Contents**

I.	INTRODUCTION .....	1
II.	BACKGROUND .....	1
	A. Procedural History .....	1
	B. The Asserted Patents.....	5
	C. Products at Issue .....	14
III.	COMMISSION REVIEW OF THE FINAL ID.....	16
IV.	ANALYSIS.....	16
	A. The Asserted Patent Claims Are Directed to an Abstract Idea and Are Patent Ineligible Under 35 U.S.C. § 101 .....	17
	B. The Asserted Claims of the '565 Patent Are Invalid Under 35 U.S.C. § 102(b) by the Sale of the [REDACTED] Product.....	35
	C. Respondents Have Not Shown That the Mercury PDC Anticipates Claims 1 and 2 of the '565 Patent and Claims 1 and 11 of the '502 Patent.....	46
	D. Respondents Have Not Shown That the Asserted Claims of the '502, '565, and '306 Patents Are Not Enabled.....	53
	E. Domestic Industry.....	56
V.	CONCLUSION.....	56

Dissenting Opinion of Commissioner Schmidlein

PUBLIC VERSION

**I. INTRODUCTION**

On May 9, 2022, the Commission determined to review in part the final initial determination (“ID”) of the presiding administrative law judge (“ALJ”), which issued on March 3, 2022. Specifically, the Commission determined to review certain of the ID’s findings relating to validity of the asserted claims of U.S. Patent Nos. 10,507,565 (“the ’565 patent”), 10,508,502 (“the ’502 patent”), and 8,616,306 (“the ’306 patent”) (collectively, “the Asserted Patents”), and the ID’s findings regarding the economic prong of the domestic industry requirement. The Commission determined not to review the ID’s finding that the sole asserted claim of the ’306 patent is invalid under 35 U.S.C. § 102(b).

On review, the Commission has determined to affirm in part, modify in part, reverse in part, and take no position on certain issues in the ID that are under review. Consistent with those determinations, the Commission affirms the ALJ’s determination that there has not been a violation of section 337 of the Tariff Act of 1930, 19 U.S.C. § 1337.<sup>1</sup> This opinion sets forth the Commission’s reasoning in support of its determination.

**II. BACKGROUND**

**A. Procedural History**

The Commission instituted this investigation on December 29, 2020, based on a complaint filed by US Synthetic Corporation (“USS” or “Complainant”) of Orem, Utah. 85 Fed. Reg. 85661-662 (Dec. 29, 2020). The complaint alleged violations of section 337 based upon the importation into the United States, the sale for importation, and the sale within the United States after importation of certain polycrystalline diamond compacts and articles containing

<sup>1</sup> Commissioner Schmidlein supports finding a violation with respect to the asserted claims of the ’502 patent. She offers below her dissenting views.

## PUBLIC VERSION

same by reason of infringement of certain claims of the '565, '502, and '306 patents and U.S. Patent Nos. 9,932,274 (“the '274 patent”) and 9,315,881 (“the '881 patent”).<sup>2</sup> *Id.* The complaint further alleged that an industry in the United States exists as required by section 337. *Id.* The notice of investigation named as respondents: SF Diamond Co., Ltd. and SF Diamond USA, Inc. (collectively, “SF Diamond”); Element Six Abrasives Holdings Ltd., Element Six Global Innovation Centre, Element Six GmbH, Element Six Limited, Element Six Production (Pty) Limited, Element Six Hard Materials (Wuxi) Co. Limited, Element Six Trading (Shanghai) Co., Element Six Technologies US Corporation, Element Six US Corporation, ServSix US, and Synergy Materials Technology Limited (collectively, “Element Six”); Iljin Diamond Co., Ltd., Iljin Holdings Co., Ltd., Iljin USA Inc., Iljin Europe GmbH, Iljin Japan Co., and Ltd., Iljin China Co., Ltd. (collectively, “Iljin”); Henan Jingrui New Material Technology Co., Ltd. (“Jingrui”); Zhenzhou New Asia Superhard Materials Composite Co., Ltd. and International Diamond Services, Inc. (“IDS”) (collectively, “New Asia”); CR Gems Superabrasives Co., Ltd. (“CR Gems”); FIDC Beijing Fortune International Diamond (“FIDC”); Fujian Wanlong Superhard Material Technology Co., Ltd. (“Wanlong”); Zhujau Juxin Technology (“Juxin”);<sup>3</sup> and Shenzhen Haimingrun Superhard Materials Co., Ltd. (“Haimingrun”). *Id.* at 85662. The Office of Unfair Import Investigations did not participate in the investigation. *Id.*

USS moved to terminate the investigation as to various respondents over the course of the investigation. All of the motions were granted by non-final IDs, and the Commission did not review them. ID at 2 (citing Order Nos. 6, 8, 10, and 16). Thus, the only remaining respondents

<sup>2</sup> The '274 and '881 patents were terminated from the investigation.

<sup>3</sup> On February 8, 2021, Guangdong Juxin Materials Technology Co., Inc. was substituted in place of Zhuhai Juxin Technology. ID at 1 n.1 (citing Order No. 8).

## PUBLIC VERSION

are Iljin, SF Diamond, New Asia, Haimingrun, Juxin, IDS, CR Gems, Jingrui, and Wanlong (collectively, “Respondents”).

USS also moved for partial termination of the investigation with respect to certain patents and claims. All of the motions were granted by non-final IDs, and the Commission did not review them. ID at 3 (citing Order Nos. 26, 32, and 57). The following asserted patents and claims were at issue in the final ID, with the independent claims in bold:

Patent	Claims
'565 patent	<b>1, 2, 4, 6, 18</b>
'502 patent	<b>1, 2, 11, 15, 21</b>
'306 patent	<b>15</b>

*Id.* (citing Order No. 59 (August 9, 2021), *unreviewed* by Comm’n Notice (Aug. 20, 2021)).

On May 24, 2021, Order No. 23 issued, which construed certain claim terms of the Asserted Patents. An evidentiary hearing was held on October 18-22, 2021.

The ALJ issued his final ID on March 3, 2022, finding no violation of section 337 by Respondents. Specifically, the ID found at least one accused product infringes all asserted claims of the Asserted Patents, but those claims are patent ineligible under 35 U.S.C. § 101 and/or invalid under 35 U.S.C. § 102. The ID also found that Complainant has shown that the domestic industry requirement has been satisfied with respect to the Asserted Patents.

On March 15, 2022, USS filed a petition for review seeking review of certain patent ineligibility and invalidity findings.<sup>4</sup> That same day, Respondents filed two contingent petitions for review.<sup>5</sup> The first petition, submitted by all active Respondents, sought review of certain

<sup>4</sup> See Complainant US Synthetic’s Petition for Review of Initial Determination (Mar. 15, 2022) (“Compl. Pet.”).

<sup>5</sup> See Respondents’ Contingent Petition for Review of the Initial Determination (Mar. 15, 2022) (“1<sup>st</sup> Resp. Pet.”); Petition for Commission Contingent Review by Zhengzhou New Asia

**SUBJECT TO PROTECTIVE ORDER**  
**PUBLIC VERSION**

findings related to infringement, the technical prong of the domestic industry requirement, and invalidity. The second petition, submitted by Respondents New Asia, Haimingrun, and Juxin, sought review of Order No. 46, which allowed Complainant to present evidence regarding its revenue-based investment allocation method for the economic prong of the domestic industry requirement. On March 23, 2022, the parties filed separate replies to the petitions for review.<sup>6</sup> On March 31, 2022, the Iljin Respondents submitted a public interest statement.

The Commission determined to review in part the final ID. 87 Fed. Reg. 29375-377 (May 13, 2022). Specifically, the Commission determined to review: (1) the ID's finding that the asserted claims are patent ineligible under 35 U.S.C. § 101; (2) the ID's finding that the asserted claims of the '565 patent are not entitled to an earlier priority date and, thus, they are invalid as anticipated by the sale of the [REDACTED] product; (3) the ID's finding that the Mercury product anticipates claims 1 and 2 of the '565 patent and claims 1 and 11 of the '502 patent; (4) the ID's finding that Respondents did not prove that the asserted claims are not enabled; and (5) the ID's findings regarding the economic prong of the domestic industry requirement (including the ruling allowing USS to supplement its domestic industry contentions with a revenue-based allocation method). The Commission determined not to review any other findings presented in the final ID, including the ID's finding that the sole asserted claim of the '306 patent is invalid under 35 U.S.C. § 102(b).

Superhard Materials Co., Ltd., Shenzhen Haimingrun Superhard Materials Co., Ltd., and Guangdong Juxin New Materials Technology Co., Ltd. (Mar. 15, 2022) ("2<sup>nd</sup> Resp. Pet.").

<sup>6</sup> See Complainant US Synthetic's Response to Respondents' Contingent Petitions for Review of Initial Determination (Mar. 23, 2022) ("Compl. Reply"); Respondents' Response to Complainant US Synthetic's Petition for Review of Initial Determination (Mar. 23, 2022) ("Resp. Reply").

## PUBLIC VERSION

The Commission also asked the parties to brief certain issues under review and to brief issues of remedy, the public interest, and bonding. The parties filed timely initial submissions<sup>7</sup> and reply submissions.<sup>8</sup>

### B. The Asserted Patents

The technology at issue in this investigation relates to polycrystalline diamond compacts (“PDCs”), which are compacts made of a polycrystalline diamond (“PCD”) and a substrate. PDCs can be shaped as cylindrical parts as shown, for example, in Fig. 11A of the ’565 patent (reproduced below) and Fig. 3B of the ’502 patent. *See, e.g.*, ’565 patent (JX-0002),<sup>9</sup> at 15:63-16:21.

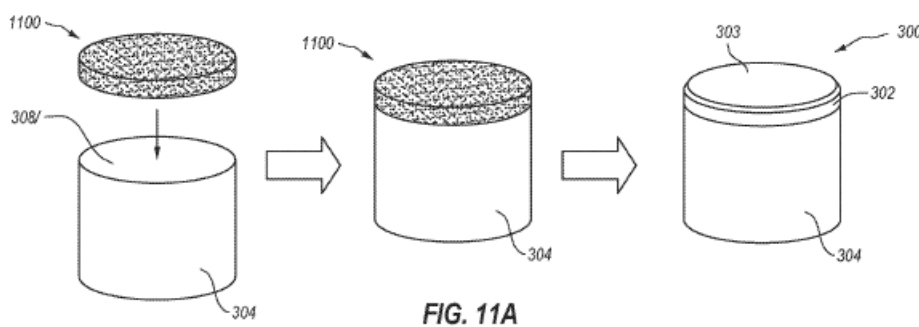

<sup>7</sup> Complainant US Synthetic’s Written Submission in Response to the Commission’s Determination to Review-In-Part a Final Initial Determination of a Violation of Section 337, EDIS Doc ID 771391 (May 23, 2022) (“Compl. Sub.”); Respondents’ Opening Submission on the Issues Under Review and on Remedy, Bond, and Public Interest, EDIS Doc ID 771380 (May 23, 2022) (“Resp. Sub.”).

<sup>8</sup> Complainant US Synthetic’s Response to Respondents’ Opening Submission on the Issues Under Review and on Remedy, Bond, and Public Interest, EDIS Doc ID 771964 (May 31, 2022) (“Compl. Reply Sub.”); Respondents’ Responsive Submission on the Issues Under Review and on Remedy, Bond, and Public Interest, EDIS Doc ID 771966 (May 31, 2022) (“Resp. Reply Sub.”).

<sup>9</sup> Citations are to the ’565 patent only. The ’502 and ’306 patents share the same specification and provide similar disclosures as the ’565 patent for purposes of this investigation unless otherwise specified.

## PUBLIC VERSION

In one disclosed embodiment, the PDC **300** includes “a superabrasive diamond layer commonly referred to as a diamond table” or “PCD table **302**,” a working surface **303** of the PCD table **302**, and a substrate **304**. *Id.* at 1:28-30, 9:44-47; *see id.* at 15:62-16:10. The substrate **304** is often made from a cemented hard metal composite, like cobalt-cemented tungsten carbide. *See id.* at 6:43-45, 9:44-45, 14:44-50. At least a portion of the PCD table **302** includes a plurality of diamond grains defining a plurality of interstitial regions. *Id.* at 4:64-67. The plurality of interstitial regions “may be occupied by a metal-solvent catalyst, such as iron, nickel, cobalt, or alloys of any of the foregoing metals.” *Id.* at 4:67-5:4. The plurality of diamond grains “may exhibit an average grain size of about 50  $\mu\text{m}$  or less, such as about 30  $\mu\text{m}$  or less or about 20  $\mu\text{m}$  or less.” *Id.* at 5:8-10.

Conventional PDCs were fabricated by placing the substrate into a cartridge with a volume of diamond particles next to the substrate. *Id.* at 1:42-46; *see* Order No. 23 (*Markman* Order) at 22 (May 24, 2021). This cartridge may be loaded into a press that creates high-pressure and high-temperature (“HPHT”) conditions. ’565 patent (JX-0002) at 1:45-46. The substrate and diamond particles are processed under the HPHT conditions in the presence of a catalyst material (*e.g.*, from the substrate) that causes the diamond particles to bond to one another, creating a PCD table that is bonded to the substrate. *Id.* at 1:46-54, 9:28-32. The ’565 patent specification explains the drawbacks to the conventional approach:

The presence of the solvent catalyst in the PCD table is believed to reduce the thermal stability of the PCD table at elevated temperatures. For example, the difference in thermal expansion coefficient between the diamond grains and the solvent catalyst is believed to lead to chipping or cracking of the PCD table during drilling or cutting operations, which can degrade the mechanical properties of the PCD table or cause failure. Additionally, some of the diamond grains can undergo a chemical breakdown or back-conversion to graphite via interaction with the solvent catalyst. At elevated high temperatures, portions of the diamond grains may

PUBLIC VERSION

transform to carbon monoxide, carbon dioxide, graphite, or combinations thereof, thus degrading the mechanical properties of the PDC.

One conventional approach for improving the thermal stability of a PDC is to at least partially remove the solvent catalyst from the PCD table of the PDC by acid leaching. However, removing the solvent catalyst from the PCD table can be relatively time consuming for high-volume manufacturing. Additionally, depleting the solvent catalyst may decrease the mechanical strength of the PCD table.

*Id.* at 1:66-2:19.

To overcome the difficulties with the conventional approaches, the specifications disclose that:

It is currently believed by the inventors that forming the PCD by sintering diamond particles at a pressure of at least about 7.5 GPa may promote nucleation and growth of diamond between the diamond particles being sintered so that the volume of the interstitial regions of the PCD so-formed is decreased compared to the volume of interstitial regions if the same diamond particle distribution was sintered at a pressure of, for example, up to about 5.5 GPa and at temperatures where diamond is stable.

*Id.* at 7:53-61. In other words, the specifications state the inventors' belief that the disclosed embodiments of PCDs sintered at a pressure of "at least about 7.5 GPa" differ from conventional HPHT products because they "may promote" "enhanced diamond-to-diamond bonding" or a "high-degree of diamond-to-diamond bonding." *Id.* at 2:27-28, 2:51-54, 4:34-35, 4:58-65, 7:53-61.

USS's expert opined that "enhanced" bonding in this context means "the level of bonding is evident typically in a cross-section micrograph, and so we're talking about more bonding, stronger bonding, larger bonds. That kind of thing would be enhanced diamond-to-diamond bonding over what had previously existed." Tr. (German) at 117:14-22; *see also* Compl. Sub. at



PUBLIC VERSION

14-15 (citing Tr. (German) at 116:8-119:25). Dr. Bertagnolli, a named inventor of the patents, also confirmed and explained how the inventors viewed this concept:

[W]e had this hypothesis that, well, if we could make the diamond table more dense, so in a sense we want less metal, less of that cobalt metal and more diamond, if we can do that, then we could keep the cutter sharper longer and our customers would be more happy with our products.

So early on in our sort of journey here, we were experimenting with ways to increase density. And one thing that we saw was that, as we increased sintering pressure, the pressure applied by the press, we saw that we would get, in the PDC, we would have a lower metal content.

And so we thought that meant that instead of so much metal being there, that meant we had *more diamond, more diamond-to-diamond bonding, greater diamond density. And, indeed, that turned out to have better wear characteristics.*

Tr. (Bertagnolli) at 67:10-68:25 (emphases added).

Disclosed embodiments of PCD tables are fabricated by subjecting a cell assembly comprising a plurality of diamond particles of about 30  $\mu\text{m}$  or less and a metal-solvent catalyst to a temperature of at least about 1000° Celsius and a pressure in the pressure transmitting medium of at least about 7.5 GPa. '565 patent (JX-0002) at 2:47-54 & Table I.

The specifications disclose that PCD tables fabricated using the disclosed embodiments may exhibit improved mechanical and/or thermal properties. Generally, as the sintering pressure that is used to form the PCD increased above 7.5 GPa, the coercivity and wear resistance or  $G_{\text{ratio}}$  of the PCD may increase while the magnetic saturation and electrical conductivity may decrease relative to PCD formed at lower pressures. *Id.* at 5:61-63, 6:63-65. The disclosed PCD tables may exhibit “a coercivity of 115 Oe or more,” “a specific magnetic saturation of about 15  $\text{G}\cdot\text{cm}^3/\text{g}$  or less, a metal-solvent catalyst content of about 7.5 weight % [] or less, an electrical

## PUBLIC VERSION

conductivity of less than about 1200 S/m,”<sup>10</sup> a  $G_{\text{ratio}}$  of “at least about  $4.0 \times 10^6$ ,” or combinations thereof. *Id.* at 4:34-49, 4:58-64, 6:66. The specifications teach “[b]y maintaining the metal-solvent catalyst content below about 7.5 wt %, the PCD may exhibit a desirable level of thermal stability suitable for subterranean drilling applications.” *Id.* at 5:28-31. The specifications posit that “[m]any physical characteristics of the PCD may be determined by measuring certain magnetic and electrical properties of the PCD because the metal-solvent catalyst may be ferromagnetic.” *Id.* at 5:32-35. Regarding coercivity, the specifications state that:

The mean free path between neighboring diamond grains of the PCD may be correlated with the measured coercivity of the PCD. A relatively large coercivity indicates a relatively smaller mean free path. The mean free path is representative of the average distance between neighboring diamond grains of the PCD, and thus may be indicative of the extent of diamond-to-diamond bonding in the PCD. A relatively smaller mean free path, in well-sintered PCD, may indicate relatively more diamond-to-diamond bonding.

*Id.* at 5:40-48. The specifications also posit that the amount of the metal-solvent catalyst present in the PCD may be correlated with the measured specific magnetic saturation and electrical conductivity ( $\sigma$ ) of the PCD. *Id.* at 5:35-39; 15:24-31. A relatively larger specific magnetic saturation indicates relatively more metal-solvent catalyst in the PCD and a relatively small amount of metal-solvent catalyst within the PCD generally indicates a relatively small value of electrical conductivity. *Id.* Moreover, the specifications disclose that the “specific permeability (*i.e.*, the ratio of specific magnetic saturation to coercivity) of the PCD may be about 0.10 or less.” *Id.* at 6:27-29. The specifications further disclose that the “ $G_{\text{ratio}}$  is the ratio of the volume of workpiece cut to the volume of PCD worn away during a cutting process,

<sup>10</sup> The “electrical conductivity of less than about 1200 S/m” language and other disclosures related to electrical conductivity were added to the continuation-in-part application that issued as the ’565 patent and do not appear in the ’502 and ’306 patents. *See infra* at Part IV(B).

## PUBLIC VERSION

such as in a vertical turret lathe (“VTL”) test in which the workpiece is cooled during the cutting process,” also known as wet VTL. *Id.* at 7:2-5; *see* Tr. (Bertagnolli) at 75:21-76:5. Thermal stability is “evaluated by measuring the distance cut in a workpiece prior to catastrophic failure, without using coolant, in a vertical lathe test (e.g., vertical turret lathe or a vertical boring mill),” also known as dry VTL. ’565 patent (JX-0002) at 7:24-28.

PDCs can be used in “drilling tools (e.g., cutting elements, gage trimmers, etc.), machining equipment, bearing apparatuses, wire-drawing machinery, and in other mechanical apparatuses.” *Id.* at 1:21-25. PDCs have found particular utility in cutters in rotary drill bits **800**, as shown in Fig. 13 of the ’565 patent below. *Id.* at 22:66-23:1, 23:11-12. A plurality of PDCs **812** are affixed to the bit body **802**, as shown in Fig. 14 below. *Id.* at 23:21-24.

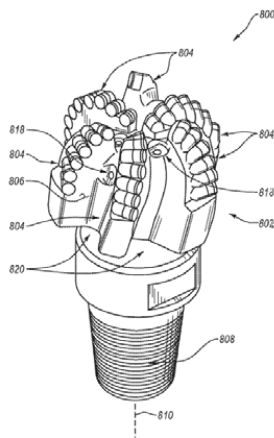

FIG. 13

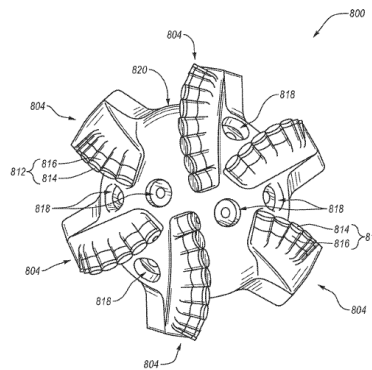

FIG. 14

A PDC with higher diamond-to-diamond bonding allows “wear parts,” such as drill bits, to last longer and perform better in high-abrasion applications, such as earth-boring. *Id.* at 8 (quoting ’502 patent (JX-0003) at 4:41-49). Thus, drill operators do not have to remove or replace the drill bits as frequently. *Id.* (citing ’502 patent at 1:26-41).

PUBLIC VERSION

Complainant alleges that Respondents infringe claims 1, 2, 4, 6, and 18 of the '565 patent, claims 1, 2, 11, 15, and 21 of the '502 patent, and claim 15 of the '306 patent.

Independent claims 1 and 18 of the '565 patent read as follows:

1. A polycrystalline diamond compact, comprising:

a polycrystalline diamond table, at least an unleached portion of the polycrystalline diamond table including:

a plurality of diamond grains directly bonded together via diamond-to-diamond bonding to define interstitial regions, the plurality of diamond grains exhibiting an average grain size of about 50  $\mu\text{m}$  or less;

a catalyst occupying at least a portion of the interstitial regions;

wherein the unleached portion of the polycrystalline diamond table *exhibits a coercivity of about 115 Oe or more*;

wherein the unleached portion of the polycrystalline diamond table *exhibits an average electrical conductivity of less than about 1200 S/m*; and

wherein the unleached portion of the polycrystalline diamond table *exhibits a  $G_{ratio}$  of at least about  $4.0 \times 10^6$* ; and

a substrate bonded to the polycrystalline diamond table.

18. A polycrystalline diamond compact, comprising:

a polycrystalline diamond table, at least an unleached portion of the polycrystalline diamond table including:

a plurality of diamond grains directly bonded together via diamond-to-diamond bonding to define interstitial regions, the plurality of diamond grains exhibiting an average grain size of about 30  $\mu\text{m}$  or less;

a catalyst occupying at least a portion of the interstitial regions;

PUBLIC VERSION

wherein the unleached portion of the polycrystalline diamond table *exhibits a coercivity of about 115 Oe to about 175 Oe*;

wherein the unleached portion of the polycrystalline diamond table *exhibits an average electrical conductivity of less than about 1200 S/m*; and

wherein the unleached portion of the polycrystalline diamond table *exhibits a thermal stability*, as determined by distance cut, prior to failure in a vertical lathe test, *of at least about 1300 m*.

'565 patent at 25:47-65 (emphasis added), 26:63-27:14 (emphasis added). Independent claims 1 and 15 of the '502 patent read as follows:

1. A polycrystalline diamond compact, comprising:

a polycrystalline diamond table, at least an unleached portion of the polycrystalline diamond table including:

a plurality of diamond grains bonded together via diamond-to-diamond bonding to define interstitial regions, the plurality of diamond grains exhibiting an average grain size of about 50  $\mu\text{m}$  or less; and

a catalyst including cobalt, the catalyst occupying at least a portion of the interstitial regions;

wherein the unleached portion of the polycrystalline diamond table *exhibits a coercivity of about 115 Oe to about 250 Oe*;

wherein the unleached portion of the polycrystalline diamond table *exhibits a specific permeability less than about 0.10 G·cm<sup>3</sup>/g·Oe*; and

a substrate bonded to the polycrystalline diamond table along an interfacial surface, the interfacial surface exhibiting a substantially planar topography;

wherein a lateral dimension of the polycrystalline diamond table is about 0.8 cm to about 1.9 cm.

PUBLIC VERSION

15. A polycrystalline diamond compact, comprising:

a polycrystalline diamond table, at least an unleached portion of the polycrystalline diamond table including:

a plurality of diamond grains bonded together via diamond-to-diamond bonding to define defining interstitial regions, the plurality of diamond grains exhibiting an average grain size of about 50  $\mu\text{m}$  or less; and

a catalyst including cobalt, the catalyst occupying at least a portion of the interstitial regions;

wherein the unleached portion of the polycrystalline diamond table exhibits:

*a coercivity of about 115 Oe to about 250 Oe;*

*a specific magnetic saturation of about 10 G·cm<sup>3</sup>/g to about 15 G·cm<sup>3</sup>/g; and*

*a thermal stability, as determined by a distance cut, prior to failure in a vertical lathe test, of about 1300 m to about 3950 m;*

wherein a lateral dimension of the polycrystalline diamond table is about 0.8 cm or more.

'502 patent at 22:61-23:13 (emphasis added), 23:65-24:17 (emphasis added). The sole asserted claim 15 of the '306 patent reads as follows:

15. A polycrystalline diamond compact, comprising:

a substrate; and

a polycrystalline diamond table including a first polycrystalline diamond layer bonded to the substrate and at least a second polycrystalline diamond layer, the second polycrystalline diamond layer exhibiting a second average diamond grain size that is less than a first average diamond grain size of the first polycrystalline diamond layer, at least an un-leached portion of the polycrystalline diamond table including:

## PUBLIC VERSION

a plurality of diamond grains defining a plurality of interstitial regions;

a metal-solvent catalyst occupying at least a portion of the plurality of interstitial regions; and

wherein the plurality of diamond grains and the metal-solvent catalyst collectively *exhibit a coercivity of about 115 Oe or more and a specific magnetic saturation of about 15 G-cm<sup>3</sup>/g or less.*

'306 patent (JX-0001) at 24:22-40 (emphasis added).

The asserted claims are directed to PDCs exhibiting certain structural features (*e.g.*, grain size and a catalyst), performance measures (*e.g.*,  $G_{\text{ratio}}$  and thermal stability), and various electrical and magnetic properties (*e.g.*, coercivity, specific magnetic saturation, specific permeability, and average electrical conductivity). The following chart summarizes the features of the PDCs in each of the asserted claims.

### Material Characteristic Features

#### '565 Patent

Claim #	Depends from	Grain Size	Coercivity	Specific Magnetic Saturation	Average Electrical Conductivity	G-Ratio	Thermal Stability
1	Ind.	< 50	>115	---	< 1200	> 4 x10 <sup>6</sup>	---
2	1	< 50	115 – 250	---	< 1200	> 4 x10 <sup>6</sup>	---
4	1	< 50	>115	< 15	< 1200	> 4 x10 <sup>6</sup>	---
6	1	< 50	>115	---	25 – 1000	> 4 x10 <sup>6</sup>	---
18	Ind.	< 30	115 – 175	---	< 1200	---	>1300

#### '502 Patent

Claim #	Depends from	Grain Size	Coercivity	Specific Magnetic Saturation	Specific Permeability	Thermal Stability
1	Ind.	<50	115 – 250	---	<0.10	---
2	1	<50	115 – 250	<15	<0.10	---
11	1	<50	115 – 250	---	<0.10	---
15	Ind.	<50	115 – 250	10 – 15	---	1300 – 3950
21	15	<50	115 – 250	10 – 15	<0.10	1300 – 3950

#### '306 Patent

Claim #	Depends from	Grain Size in Layers	Coercivity	Specific Magnetic Saturation
15	Ind.	$d_{(2\text{nd layer})} < d_{(1\text{st layer})}$	>115	< 15

### C. Products at Issue

Pursuant to Commission Rule 210.10(b)(1), 19 C.F.R. § 210.10(b)(1), the plain language description of the accused products or category of accused products, which defines the scope of

the investigation, is “polycrystalline diamond compacts (PDC), PDC cutters, drill bits including PDC cutters, and PDC bearings and bearing elements.” 85 Fed. Reg. 85662.

**1. The Accused Products**

The following product lines are accused of infringement:

Party	Infringing Product Series	Asserted Claims Practiced		
		'565	'502	'306
Iljin	UP8N	1, 2, 4	1, 2, 11	
	UP9N	1, 2, 4, 6, 18	1, 2, 11	
New Asia / IDS	Dragon 2	1, 2, 4, 6	1, 2, 11	15
SF Diamond	[REDACTED]		1, 2, 11	15
	[REDACTED]		1, 2, 11	15
	[REDACTED]	1, 2, 4	1, 2, 11	15
	[REDACTED]		1, 2, 11	15
[REDACTED]	[REDACTED]	1, 2, 4, 18	1, 2, 11, 15, 21	15
Haimingrun	C20	1, 2, 4	1, 2, 11	
	S18	1, 2, 4, 6	1, 2, 11	15
	C19		1, 2, 11	
Juxin	RC		1, 2, 11	
	C2		1, 2, 11	
	Z1		1, 2, 11	15
	Z2		1, 2, 11	15
Jingrui	R11A	1, 2, 4, 6, 18	1, 2, 11, 15, 21	
	R22	1, 2, 4, 6, 18	1, 2, 11, 15, 21	
Wanlong	ZT2-B	1, 2, 4, 6, 18	15	
	ZTA-B	1, 2, 4, 18	15	
	RFA-B	1, 2, 4, 6, 18	15	
	RF2-B	1, 2, 4, 6, 18	15	
CR Gems*	GPCD-CRM	1, 2, 4, 6	1, 11	
	GPCD-M/69	1, 2, 4, 6	1, 11	

ID at 10. SF Diamond has a redesigned line of products called the A-series, which the ID found is properly within the scope of the investigation and does not infringe any asserted patent claims. *Id.* at 11, 39-43, 55, 68, 77.

**2. The Domestic Industry Products**

The following USS products are alleged to practice the Asserted Patents:

Patents	Part Numbers
'502 Patent, '565 Patent	40127-01 (16 mm [REDACTED]), 40095-01 (16 mm [REDACTED] various), 40133-01 (16 mm [REDACTED]), 40233-01 (16 mm [REDACTED]) (“DI I Products”)
'306 Patent	40233-01 (16 mm [REDACTED]) (“DI II Product”)



**SUBJECT TO PROTECTIVE ORDER**  
**PUBLIC VERSION**

CDX-0004C.9. The “DI I Products” allegedly practice claims of the ’565 and ’502 patents and the “DI II Product” allegedly practice claims of the ’306 patent. ID at 90-92.

**III. COMMISSION REVIEW OF THE FINAL ID**

With respect to the issues under review, “the Commission may affirm, reverse, modify, set aside or remand for further proceedings, in whole or in part, the initial determination of the administrative law judge.” 19 C.F.R. § 210.45(c). The Commission also “may take no position on specific issues or portions of the initial determination,” and “may make any finding or conclusions that in its judgment are proper based on the record in the proceeding.” *Id.*

**IV. ANALYSIS**

The Commission did not review, and thus adopted, the ID’s finding that the sole asserted claim of the ’306 patent is invalid under 35 U.S.C. § 102(b) and, therefore, USS has not established a violation of section 337 with respect to the ’306 patent. On review, the Commission has determined that USS has also not established a violation of section 337 with respect to claims 1, 2, 11, 15, and 21 of the ’502 patent and claims 1, 2, 4, 6, and 18 of the ’565 patent. Specifically, the Commission affirms with modifications the ID’s finding that the asserted claims are directed to an abstract idea and, thus, are patent ineligible under 35 U.S.C. § 101. The Commission also affirms with modifications the ID’s finding that the asserted claims of the ’565 patent are invalid under 35 U.S.C. § 102(b) by the sale of the [REDACTED] product. Because the Commission finds certain testimony from third-party Diamond Innovations, Inc.’s (“Diamond Innovations”) witness should be stricken in view of the ALJ’s rulings in Order No. 48 and at trial, the Commission reverses the ID’s finding that the Mercury PDC anticipates claims 1 and 2 of the ’565 patent and claims 1 and 11 of the ’502 patent. The Commission further affirms with modification the ID’s finding that Respondents have not proven that the asserted claims of the ’502, ’565, and ’306 patents are not enabled. Finally, in view of the

## PUBLIC VERSION

Commission’s finding that all asserted claims are directed to patent ineligible subject matter and/or invalid, the Commission takes no position on the ID’s economic prong findings, including the ALJ’s determination to allow USS to supplement its contentions with a new domestic industry allocation method. The Commission affirms and adopts the ID’s findings, conclusions, and supporting analysis that are not inconsistent with the Commission’s opinion.<sup>11</sup>

**A. The Asserted Patent Claims Are Directed to an Abstract Idea and Are Patent Ineligible Under 35 U.S.C. § 101**

“The statement of patent-eligible subject matter has been substantially unchanged since the first Patent Act in 1790.” *Classen Immunotherapies, Inc. v. Biogen IDEC*, 659 F.3d 1057, 1063 (Fed. Cir. 2011). As now codified, it reads:

§ 101. Whoever invents or discovers any new and useful process, machine, manufacture, or composition of matter, or any new and useful improvement thereof, may obtain a patent therefor, subject to the conditions and requirements of this title.

*Id.*; 35 U.S.C. § 101. The Supreme Court has “long held that this provision contains an important implicit exception: Laws of nature, natural phenomena, and abstract ideas are not patentable.” *Alice Corp. v. CLS Bank Int’l*, 573 U.S. 208, 216 (2014).

The determination of whether a claim is directed to ineligible subject matter is based on a two-step test set forth by the Supreme Court in *Alice*. The first step evaluates “whether the claims at issue are directed to one of [the] patent-ineligible concepts”—“laws of nature, natural phenomena, and abstract ideas.” *Id.* at 217. The Court explained that the “abstract ideas”

<sup>11</sup> Commissioner Schmidlein joins the Commission’s decision affirming the ID’s section 102 findings as modified in the Majority opinion but dissents from the Majority’s decision to affirm the ID’s section 101 findings as explained below in her dissenting views. She would also affirm with modifications the ID’s conclusion that USS established the economic prong of the domestic industry requirement for the ’565 patent and the ’502 patent under subsections (A), (B), and (C) of 337(a)(3). Accordingly, she would find a violation based on infringement of claims 1, 2, 11, 15, and 21 of the ’502 patent.

## PUBLIC VERSION

category embodies “the longstanding rule that “[a]n idea of itself is not patentable.” *Id.* at 218; *see Le Roy v. Tatham*, 55 U.S. 156, 175 (1852) (“A principle, in the abstract, is a fundamental truth; an original cause; a motive; these cannot be patented, as no one can claim in either of them an exclusive right.”). Speaking specifically to the issue of whether a claim is directed to an abstract idea, the Court said to consider whether the claim seeks to cover a “fundamental [] practice” or basic “building block.” *Alice*, 573 U.S. at 220, 217.

The Federal Circuit has described the first-stage inquiry as looking at the “focus” of the claims, “whether the claim, as a whole” is “directed-to” patent-ineligible matter such as an abstract idea. *Elec. Power Grp., LLC v. Alstom S.A.*, 830 F.3d 1350, 1353 (Fed. Cir. 2016); *see Ancora Techs., Inc. v. HTC Am., Inc.*, 908 F.3d 1343, 1347 (Fed. Cir. 2018). This inquiry involves determining whether the claims “focus on a specific means or method that improves the relevant technology” or are “directed to a result or effect that itself is the abstract idea and merely invoke generic processes and machinery.” *Apple, Inc. v. Ameranth, Inc.*, 842 F.3d 1229, 1241 (Fed. Cir. 2016).

If a claim is directed to a patent-ineligible concept, the second step evaluates whether the claim’s elements both individually and as an ordered combination of elements transform the nature of the claim into a patent-eligible application. *Alice*, 573 U.S. at 217. The Federal Circuit has described the second-stage inquiry as looking more precisely at what the claim elements add, whether they identify an “inventive concept” in the application of the ineligible matter to which the claim is directed. *Elec. Power Grp.*, 830 F.3d at 1353.

Before applying the two-step *Alice* test, the Commission first addresses USS’s argument that “Respondents waived their abstract idea argument because they raised it for the first time in their Post-Hearing Brief.” Compl. Sub. at 6. USS asserts that Respondents previously only

## PUBLIC VERSION

argued that the claims are “directed to laws of nature, but never abstract ideas which is a different framework.” *Id.* However, USS failed to argue waiver of this issue in its petition for review, and thus has waived its own waiver argument. *See* Compl. Pet. at 14-39; 19 C.F.R. § 210.43(b). Regardless, Respondents did not waive their argument. While Respondents repeatedly referred to the claimed properties as “natural phenomena” in their prehearing brief, *see* Resp. Pre-Hearing Br. at 61, 65, they characterized the claims as “directed to abstract subject matter,” *id.* at 71, and cited case law that found claims unpatentable under the abstract idea judicial exception, *see, e.g., id.* at 67, 68, 72. Moreover, other than its conclusory assertion, USS does not articulate or show support for any “different framework” for analyzing patent claims purportedly directed to abstract ideas as opposed to laws of nature. Compl. Sub. at 6. There is no indication in the case law that different principles or modes of analysis apply to these judicially recognized exceptions. *See Am. Axle & Mfg., Inc. v. Neapco Holdings LLC*, 967 F.3d 1285, 1297 (Fed. Cir. 2020) (stating the “same principle” applies in cases involving the abstract idea and natural law), *cert. denied*, 142 S. Ct. 2902 (2022); *Smart Sys. Innovations, LLC v. Chicago Transit Authority*, 873 F.3d 1364, 1377 (Fed. Cir. 2017) (J. Linn dissenting in part and concurring in part) (“[T]here is no principled difference between the judicially recognized exception relating to ‘abstract ideas’ and those relating to laws of nature and natural phenomena. All three nonstatutory exceptions are intended to foreclose only those claims that preempt and thereby preclude or inhibit human ingenuity with regard to basic building blocks of scientific or technological activity.”).

### 1. *Alice* Step One

Regarding *Alice* step one, the ID observed that the asserted claims “recite compositions of matter that are not found in nature,” but they also recite “certain structural and design features (for example, a particular grain size and a catalyst), performance measures (G-Ratio . . . and

## PUBLIC VERSION

thermal stability . . .), and side effects (the various electrical and magnetic parameters).” ID at 102, 104; *see also id.* at 100, 134. The ID found the structural and design features are not problematic under *Alice* but the performance measures and side effects are problematic. *Id.* at 104-105. Specifically, relying on the patent specifications and one of Dr. Bertagnolli’s published papers, the ID found that the properties of “wear resistance” and “thermal resilience,” as measured by  $G_{ratio}$  and thermal stability, respectively, “are not merely results or effects, but are actually performance measures.” *Id.* at 102 (citing JX-0002 (’565 patent) at 2:22-28; CX-0394.3 (“wear resistance,” “thermal resilience,” and fracture toughness are three “properties relevant to drilling”)). The ID also found that Dr. Bertagnolli’s paper and the patents explain that the claimed electrical and magnetic properties are “side effect[s] or result[s] of the fabrication processes and microscopic characteristics of a PDC.” *Id.*; *see also id.* at 103-104. The ID summarized the patented inventions as follows:

In short, nothing in the asserted patents, or the rest of the record, suggests that any of these parameters solve any problems, rather than simply being measures of other, actually beneficial characteristics. Nor are the electrical and magnetic parameters sufficiently tied to any such beneficial characteristics through inherency, as explained above. There may be some causal connection between grain size, catalyst concentration, and other, unspecified design and fabrication choices, on the one hand, and electrical and magnetic behavior, on the other hand. But that causal connection is so loose and generalized that the claimed limitations appear to be little more than side effects; thus, the recitation of, say, an electrical conductivity of less than 1200 S/m appears to be gratuitous rather than inventive.

*Id.* at 104. Thus, the ID concluded that the asserted claims are directed to patent ineligible matter.

USS argues that the asserted claims are directed to “manmade PDCs—patent-eligible articles of manufacture and compositions of matter,” which are “quintessential patent-eligible subject matter under 35 U.S.C. § 101.” Compl. Sub. at 5, 3. However, under well-settled law,

## PUBLIC VERSION

that a claim recites an article of manufacture, or a composition of matter, is not determinative of whether it is in fact directed to an abstract idea. *Yu v. Apple Inc.*, 1 F.4<sup>th</sup> 1040, 1044 & n.2 (Fed. Cir. 2021) (finding claims directed to an “improved digital camera” patent ineligible under § 101). The Supreme Court confirmed in *Alice* that what matters is the reality behind the machine or system claim language, whether or not it simply clothes abstract concepts.

The fact that a computer “necessarily exist[s] in the physical, rather than purely conceptual, realm,” Brief for Petitioner 39, is beside the point. There is no dispute that a computer is a tangible system (in § 101 terms, a “machine”), or that many computer-implemented claims are formally addressed to patent-eligible subject matter. But if that were the end of the § 101 inquiry, an applicant could claim any principle of the physical or social sciences by reciting a computer system configured to implement the relevant concept. Such a result would make the determination of patent eligibility “depend simply on the draftsman’s art,” *Flook, supra*, at 593, 98 S.Ct. 2522, thereby eviscerating the rule that “[l]aws of nature, natural phenomena, and abstract ideas are not patentable,” *Myriad*, 569 U.S., at —, 133 S.Ct., at 2116.

*Alice*, 573 U.S. at 224. Just as the “digital camera” in *Yu* is directed at patenting an abstract idea, so too is the “polycrystalline diamond compact” here.

USS next argues that, instead of determining whether the claim, as a whole, is directed to an abstract idea, the ID improperly “created its own framework, looking at individual claim elements, bucketing the elements into different groups, and analyzing whether each group is directed to an abstract idea.” Compl. Sub. at 5 (citing ID at 101-107). According to USS, the ID then “blessed one group as ‘structural’ (e.g., a particular grain size and a catalyst) and condemned other groups as merely ‘side effects’ (e.g., magnetic saturation, coercivity, and specific permeability) or ‘performance measures’ (e.g., G-Ratio and thermal stability).” *Id.* (citing ID at 102, 104).

We consider the ID to have examined the claims as a whole in determining that they were directed to an abstract idea and that the ID’s level of abstraction in discussing what the claims

## PUBLIC VERSION

are “directed to” does not meaningfully impact the patentability analysis. The Federal Circuit has recognized that an “abstract idea can generally be described at different levels of abstraction.” *Ameranth*, 842 F.3d at 1340-41. Here, the ID examined the language of the claims as a whole, explaining that it found certain claim elements to be performance measures or side effects rather than structural or design parameters. *See, e.g.*, ID at 105 (finding that the “claims of the ’565 patent [] incorporate the [abstract] goal or result of a particular measure of wear resistance (i.e., G-Ratio) or thermal resilience (i.e., thermal stability), however achieved,” and “certain electrical and magnetic side effects that themselves are simply imperfect proxies for unclaimed features”). It is clear from the language of the claims that the claims involve an abstract idea—namely, the abstract idea of a PDC that achieves the claimed performance measures (G-Ratio and thermal stability) and has certain measurable side effects (specific magnetic saturation, coercivity, and specific permeability), which, as discussed below, the specifications posit are derived from enhanced diamond-to-diamond bonding in the PDCs.

While the “directed to” inquiry must focus on the language of the claims themselves, the Federal Circuit has explained that “the specification may [] be useful in illuminating whether the claims are ‘directed to’ the identified abstract idea.” *ChargePoint, Inc. v. SemaConnect, Inc.*, 920 F.3d 759, 767 (2019) (“The ‘directed to’ inquiry “may also involve looking to the specification to understand ‘the problem facing the inventor’ and, ultimately, what the patent describes as the invention.”). Here, the specifications suggest that the asserted claims are directed to the abstract idea of PDCs that achieve the claimed performance measures and have side effects that the inventors believed may be derived from “enhanced” or “a high-degree of

## PUBLIC VERSION

diamond-to-diamond bonding.” *See, e.g.*, ’565 patent<sup>12</sup> (JX-0002) at Abstract (“Embodiments of the invention relate to polycrystalline diamond compacts (‘PDC’) exhibiting enhanced diamond-to-diamond bonding.”), 2:20-29 (patent purports to disclose “PCD materials that exhibit improved mechanical and/or thermal properties” via “enhanced diamond-to-diamond bonding”), 4:58-64 (“According to various embodiments, unleached PCD sintered at a pressure of at least about 7.5 GPa may exhibit . . . a high-degree of diamond-to-diamond bonding . . .”), 7:47-52 (“[I]n one or more embodiments of the invention, PCD exhibits . . . a greater amount of diamond-to-diamond bonding between diamond grains than that of a PCD sintered at a lower pressure . . .”), 21:17-29 (conventional PDC tables listed in Table II exhibit “a lower coercivity indicative of a relatively greater mean free path between diamond grains, and thus may indicate relatively less diamond-to-diamond bonding between the diamond grains”).

The problem identified in the specifications was that the “residual stresses” in the PCD table and substrate following the HPHT process “may result in premature failure of the PDC.” ’565 patent (JX-0002) at 1:62-2:7; *see* ’502 patent (JX-0003) at 1:62-2:7. The specifications state that the inventors believed that “forming the PCD by sintering diamond particles at a pressure of at least about 7.5 GPa may promote nucleation and growth of diamond between the diamond particles being sintered,” thereby forming a PCD “having a metal-solvent catalyst content of less than about 7.5 wt %.” ’565 patent (JX-0002) at 7:53-8:5. The specifications also state the inventors’ belief that PCDs formed at a sintering pressure above 7.5 GPa and with the metal-solvent catalyst content below about 7.5 wt % may exhibit increased wear resistance and improved thermal stability. *Id.* at 4:54-57, 5:43-44, 5:63-64, 6:14-22. In short, looking at the

<sup>12</sup> Citations are to the ’565 patent only. The ’502 and ’306 patents provide similar disclosures. *See* ’502 patent (JX-0003) at 2:19-20, 3:66-4:12, 4:21-24, 6:45-59; ’306 patent (JX-0002) at 2:16-18, 3:64-4:9, 4:18-23, 6:44-52.



## PUBLIC VERSION

problem identified in the patents, as well as the way the inventors describe their invention, the Commission finds that the claims are directed to the abstract idea of PDCs that achieve the claimed performance measures and desired magnetic and electrical results, which the specifications posit may be derived from enhanced diamond-to-diamond bonding.

The Commission finds that the concept of stronger PDCs that achieve certain performance measures and desired magnetic and electrical properties is an abstract idea for purposes of *Alice* step one.<sup>13</sup> USS does not dispute that the focus of the claims is stronger bonding. *See* Tr. (German) at 116:8-16 (testifying that the disclosed PDCs are differentiated from prior art PDCs by “the key term [that] shows up in both the summary and the abstract, and it says *enhanced diamond-to-diamond bonding*”) (emphasis added), 117:7-12 (testifying that “embodiments of the invention relate to polycrystalline diamond compacts exhibiting enhanced diamond-to-diamond bonding”), 118:12-119:15 (testifying that although the word “enhanced” is not in the claims, “the implications from the – the relative properties that follow in both of those claims would be satisfied by an enhanced level of bonding”).

USS argues that achieving the claimed properties and stronger bonding are not abstract ideas. *See* Compl. Pet. at 7-10. Central to USS’s argument and the dissent’s view is that the claims are directed to “objective measurements” of the diamond microstructure and the measurements are, thus, “structural elements.” Compl. Sub. at 4, 5. In its petition for review, USS asserts:

<sup>13</sup> There is no dispute that the main goal for the PDC industry is enhanced or more diamond-to-diamond bonding. *See* Resp. Sub. at 13-14 (stronger bonding is “top of mind for everyone in the PDC industry”) (citing Tr. (German) at 119:17-25 (USS’s expert noting that “enhanced diamond-to-diamond bonding” is “driving the economics” in the drill rig industry)); *Alice*, 573 U.S. at 218 (defining an abstract idea as “a fundamental truth; an original cause; a motive”) (quoting *Le Roy*, 55 U.S. at 175).

## PUBLIC VERSION

Before the claimed invention, USS and others believed that sintering a PDC at too high a pressure could cause problems, such as exerting strain on the press equipment. [Tr. (Bertagnolli)], 73:3-9. Extremely high pressures can also destroy the press. *Id.*, 68:8-11. Through significant R&D efforts, USS developed a way to exert higher sintering pressure (e.g., 7.8 GPa). *See* CX-2349. These manufacturing methods led to a new type of PDC with more diamond bonding and less cobalt.

Compl. Pet. at 7. USS submits that “each parameter measures how tightly the diamond grains in the PCD table are packed together, indicating a greater diamond density, which is directly tied to the PDC’s superior performance in drilling applications.” Compl. Sub. at 28; *see also id.* at 9 (the asserted claims “claim *how* an enhanced or a high-degree of diamond-to-diamond bonding is achieved with measurements within associated numerical ranges). USS argues that “many claim features are observed or measured in some way,” and if such features are found abstract, “the abstract-idea exception would spill well beyond its boundaries.” Compl. Reply Sub. at 2.

The evidence does not support USS’s argument that the claimed properties are “structural elements” of a PDC or indicative of any specific microstructure. Instead, as USS’s expert agreed, the measurable characteristics are the result of the sintering conditions and input materials that went into manufacturing the PDC. Tr. (German) at 1338:24-1339:4. Thus, as the ID states,  $G_{ratio}$  and thermal stability are performance measurements (specifically of a PDC’s wear resistance and thermal properties), which the specifications posit may be derived from stronger diamond-to-diamond bonding. *See* ID at 102 (citing ’565 patent at 2:22-28, 6:64-66, 7:16-39; CX-0394.3); Tr. (German) at 119:5-15 (testifying “G-ratio [] is a wear characteristic,” “[t]he higher the G-ratio, as we would know, is more successful [] the diamond cutter would be.”).

As for the electrical and magnetic properties of a PCD, there is no dispute that the presence of cobalt or other metal-solvent catalyst in the PCD is measurable. *See* Tr. (German) at

## PUBLIC VERSION

156:10-16 (testifying that coercivity measures “the degree of magnetization necessary to take [a PCD] sample back to zero magnetism”); ’565 patent (JX-0002) 5:49-60 (the specification teaches to measure the coercivity and specific magnetic saturation using published standards and commercially available instruments). However, USS has not proven that the claimed electrical and magnetic properties are indicative of any specific microstructure. *See* ID at 102-104 (citing CX-0394.2-3). Relying on the patent specifications and Dr. Bertagnolli’s paper, the ID found the electrical and magnetic properties are “not design choice[s] or manufacturing variable[s], but are instead [] indirect measures of the effectiveness of other design choices and manufacturing variables,” such as sintering pressure, temperature, metal content, and grain size, none of which, besides grain size, are recited in the claims. ID at 103. We agree with the ID that “[t]here may be some causal connection between grain size, catalyst concentration, and other, unspecified design and fabrication choices, on the one hand, and electrical and magnetic behavior, on the other hand,” “[b]ut that causal connection is so loose and generalized that the claimed limitations appear to be little more than side effects; thus, the recitation of, say, an electrical conductivity of less than 1200 S/m appears to be gratuitous rather than inventive.” *Id.* at 104.

Contrary to the dissent’s view, the fact that the claimed characteristics of PDCs may be measured does not make the claims any less abstract for purposes of *Alice*. The Federal Circuit has explained that the patent eligibility inquiry requires that the claim “identify ‘how’ [a] functional result is achieved by limiting the claim scope to structures specified at some level of concreteness, in the case of a product claim, or to concrete action, in the case of a method claim.” *Am. Axle*, 967 F.3d at 1302. The Court noted that the “Supreme Court has so required dating back at least to the Court’s rejection of Morse’s claim 8 in *O’Reilly v. Morse*.” *Id.* The Court explained that Morse’s claim 8 was struck down because “it ‘was a claim for a patent for an

## PUBLIC VERSION

effect produced by the use of electro-magnetism, distinct from the process or machinery necessary to produce it,' whereas other claims incorporated the descriptions of how to produce the effect." *Id.* at 1302 n.14 (quoting *Dolbear v. Am. Bell Tel. Co.*, 8 S. Ct. 778, 782 (1888)) (internal quotations omitted); *see also Interval Licensing LLC v. AOL, Inc.*, 896 F.3d 1335, 1342-43 (Fed. Cir. 2018) (explaining that the inventor in *Morse* "received a patent containing at least one claim directed to a particular technical solution to a problem," but also "lost a claim that encompassed all solutions for achieving a desired result," because the latter claim "failed to recite a practical way of applying an underlying idea; [it] instead [was] drafted in such a result-oriented way that [it] amounted to encompassing the 'principle in the abstract' no matter how implemented."). Thus, while it is not *per se* impermissible to claim PDCs that achieve certain properties and stronger bonding characteristics, the claims run afoul of section 101 due to the "essentially result-focused, functional character of claim language."<sup>14</sup> *Elec. Power Grp.*, 830 F.3d at 1356. The claims here cover a set of goals for the PDCs that the specifications posit may be derived from enhanced diamond-to-diamond bonding. The claims do not recite a way of achieving the claimed characteristics; they simply recite the desired range of values for each characteristic. Some claims do not even place a cap on those ranges.

<sup>14</sup> The dissent argues the claimed properties at issue here are not the sort of results that have been called into question in cases related to software functionality in computers. The dissent reads these cases too narrowly, and the principles expressed in those cases are not limited to cases involving software or computers. Moreover, while recent abstract idea precedent has focused on computer-based and business method patents, the judicially recognized exceptions can be found in more than these fields. *See, e.g., Le Roy*, 55 U.S. at 174-76 (articulating the abstract idea exception in discussing claims directed to making lead pipes); *Funk Bros. Seed Co. v. Kalo Inoculant Co.*, 333 U.S. 127, 130-32 (1948) (product claims to composite cultures of inoculants); *O'Reilly v. Morse*, 56 U.S. 62, 112-13 (1853) (claims directed to the use of electro-magnetism for marking or printing characters).

## PUBLIC VERSION

The details set forth in the specifications do not change the conclusion under *Alice* step one. The specifications set forth various manufacturing conditions and input materials, and teach that these conditions and inputs may produce PCDs having improved mechanical and/or thermal properties over the prior art. '565 patent (JX-0002) at 2:47-54, 5:61-63, 6:63-65. However, other than grain size, none of these conditions/inputs are required by the claims. Moreover, USS contends and the ALJ agreed that the patentees did not disavow the claim scope to limit certain parameters. *See* Order No. 23 (*Markman* Order) at 18-20 (construing claims “such that there is no requirement for all PDCs to have been made with a sintering pressure of at least 7.5 GPa . . . .”); Compl. Reply at 20 (denying patentees limited claims to PCD tables manufactured with a cell pressure of 7.5 GPa or above and a metal-solvent catalyst amount of 7.5 wt. % or less”). In other words, the asserted claims cover all PDCs exhibiting the claimed properties no matter what pressure was used to make them or how much catalyst is present in the PCD. Unclaimed features of the manufacturing process “cannot function to remove [the claims] from the realm of ineligible subject matter.” *Am. Axle*, 967 F.3d at 1295 (citing *ChargePoint*, 920 F.3d at 766).

Recently, in *Certain Light-Emitting Diode Products, Fixtures, and Components Thereof*, Inv. No. 337-TA-1213 (“*Light-Emitting Diode*”), the Commission found a claim that recites, *inter alia*, a lighting device “having a wall plug efficiency of at least 85 lumens per watt of said electricity” is directed to the abstract goal of energy efficiency at or above 85 LPW, however that goal is achieved. Final ID at 21-22, 2021 WL 3829977, at \*19-20 (Aug. 17, 2021), *aff’d* by Comm’n Op., 2022 WL 168302, at \*3 (Jan. 14, 2022). There, the complainant had argued that the claim is not directed to an abstract goal because it recites “a particular physical structure (a ‘lighting device’) with objective, measurable characteristics (a ‘wall plug efficiency’).” Resp.

## PUBLIC VERSION

Sub. at 18 (quoting *Light-Emitting Diode*, Compl. Pet. at 28). The Commission adopted the ALJ's finding that the claims are directed to an abstract goal because "the *claims themselves*, even when properly construed in light of the specification, do not delineate how the claimed [result (*i.e.*, efficiency)] is achieved." *Light-Emitting Diode*, Final ID at 23, 2021 WL 3829977 at \*20. USS attempts to distinguish *Light-Emitting Diode* by arguing that the claim at issue recited "one novel structural element," *i.e.*, "a wall plug efficiency of at least 85 lumens per watt of said electricity," whereas the asserted claims here recite numerous parameters, "the combination of which defines the claimed microstructure with enhanced diamond-to-diamond bonding." Compl. Reply Sub. at 7. USS does not cite any cases to support its argument that the number of parameters claimed somehow matters in the patent eligibility inquiry, particularly given that the testing data discussed below contradicts USS's assertion that the parameters it claims define a particular microstructure.

The testimony submitted by USS highlights that its research and development efforts resulted in the ability to manufacture PDCs at higher pressure without damaging the manufacturing press. Tr. (Bertagnolli) at 67:10-68:25. But rather than claiming a specific structure or way of making a PDC, or any improvements to the manufacturing equipment itself, USS purports to monopolize every potential structure or way of creating stronger PDCs with the claimed characteristics. Whereas patenting a particular solution "would incentivize further innovation in the form of alternative methods for achieving the same result," allowing claims like USS's claims here would "inhibit[ ] innovation by prohibiting other inventors from developing their own solutions to the problem without first licensing the abstract idea." *Elec. Power Grp.*, 830 F.3d at 1356.

SUBJECT TO PROTECTIVE ORDER

PUBLIC VERSION

Courts have found that preemption is an indication that claims are directed to an abstract idea. *See ChargePoint*, 920 F.3d at 766 (“[T]he concern that drives the judicial exceptions to patentability is one of preemption[.]”) (internal quotation marks omitted). USS contends that the “Asserted Claims do not cover all PCDs with enhanced diamond-to-diamond bonding, but rather PDCs with the type of diamond-to-diamond bonding characterized by the numerical parameters recited in the claims.” Compl. Reply Sub. at 11. In particular, the dissent agrees with USS that there is no preemption here because the claims do not cover “the conventional PDCs disclosed in the specification of the Asserted Patents (*see, e.g.*, JX-0002.31-.32 at Tbls. II-III), several products tested in this Investigation (*see, e.g.*, CX-0383C.5, .7), and SF Diamond’s redesign products developed during this Investigation (*see* ID at 55, 68).” Compl. Reply Sub. at 20. The Commission finds this argument unpersuasive. The fact that one respondent, SF Diamond, was able to redesign its product with a [REDACTED] than what is claimed, *see* ID at 77, does not render the preemption concern moot. Either [REDACTED] is irrelevant (contrary to USS’s assertion) and SF Diamond’s redesign is equivalent to the patented PDCs, or the only path forward for others is practicing the inferior prior art PDCs. USS seeks a monopoly on any PDCs that exhibit the claimed properties however achieved, which the law precludes in these circumstances.

The evidence also shows that certain accused products in this case achieved the claimed properties using manufacturing conditions and input materials different from those disclosed in the specifications. *See* Resp. Sub. at 8-9 (citing Resp. Reply at 17-18; CX-0383C; Tr. (German) at 375:2-19; JX-0192C). For example, respondent Haimingrun’s accused S18 product was found infringing because it met all of the coercivity, magnetic saturation, permeability, and electrical conductivity thresholds. ID at 10, 63-64 (citing CX-0383C.3-4); CDX-0003C.77-78. Yet, the

SUBJECT TO PROTECTIVE ORDER  
PUBLIC VERSION

S18 product was manufactured at a sintering pressure of [REDACTED] GPa and included a catalyst weight percentage of more than [REDACTED]. JX-0192C; CX-0383C.3-4; *cf.* '565 patent (JX-0002) at 5:28-31, 5:64-6:3, 6:63-65 (teaching embodiments with less than 7.5% wt catalyst and greater than 7.5 GPa sintering pressure). USS contends that JX-0192C shows the S18 product was manufactured at a cell (cavity) pressure above [REDACTED] GPa. Compl. Reply Sub. at 21. However, JX-0192C (at 1) lists the cavity pressure measurement as [REDACTED] GPa for the S18. The Commission finds USS's attorney argument insufficient to disregard the express statement in the document. Moreover, even if USS is correct that the S18 product was manufactured at cell pressure above [REDACTED] GPa, USS does not challenge Respondents' assertion that the S18 product had a catalyst weight percentage of more than [REDACTED], which goes against the teachings in the patents.

As another example, respondent New Asia's accused Dragon 2 product was found to meet all the claimed property thresholds, but New Asia reported that it was manufactured at a sintering pressure of less than 7.5 GPa. *See* ID at 64 (citing CX-0383C.3), 68-70; CDX-0003C.77-78; CDX-0003C.151; Tr. (German) at 375:2-19 (confirming that New Asia reported "the Dragon 2 product, even though it's an accused product, is manufactured using less than 7.5 gigapascals" and "greater than the 7.5 percent cobalt or metal-solvent catalyst content described in the asserted patents"). USS now argues that "New Asia's *pre-suit* documents . . . touted that its PDC products are manufactured at [REDACTED] GPa." Compl. Reply Sub. at 22 (citing JX-0348C). JX-0348C is not an admitted exhibit and, therefore, the Commission gives no weight to this exhibit. Moreover, USS has not shown that the "*pre-suit* documents" relate to the specific PDC samples tested for infringement, and its own expert did not question New Asia's reported sintering pressure.



## PUBLIC VERSION

In view of the above, we agree with Respondents that the fact that PDCs produced with manufacturing conditions and input materials different from what is taught in the patents may still satisfy the claimed characteristics contradicts USS's assertion that the measured properties "characterize the PDC's microstructure" and "are structural parameters." Resp. Sub. at 19; Compl. Pet. at 20. This is especially problematic because, as Respondents point out, even assuming that the PCD embodiments in Table I have "enhanced" diamond-to-diamond bonds, as the patents posit, the claimed ranges are broader than the ranges of the embodiments in Table I, "illustrating that the claims are not limited to whatever microstructure those embodiments might have." Resp. Sub. at 13.

To the extent that the dissent agrees with USS that "broad preemption" is required to indicate the claims are directed to an abstract idea, Compl. Reply Sub. at 12, the Supreme Court has rejected that notion. The Court explained that "the underlying functional concern here is a *relative* one: how much future innovation is foreclosed relative to the contribution of the inventor." *Mayo Collaborative Servs. v. Prometheus Labs., Inc.*, 566 U.S. 66, 89 (2012) (citation omitted). "A patent upon a narrow law of nature may not inhibit future research as seriously as would a patent upon Einstein's law of relativity, but the creative value of the discovery is also considerably smaller." *Id.* at 88. And, as the Court recognized, "even a narrow [ineligible subject matter] can inhibit future research." *Id.* The Court said that its "cases have endorsed a bright-line prohibition against patenting laws of nature, mathematical formulas, and the like, which serves as a somewhat more easily administered proxy for the underlying 'building-block' concern." *Id.* at 89; *see also Alice*, 573 U.S. at 217 (claims directed to no more than a "fundamental [] practice" or basic "building block" of human ingenuity are not patentable because doing so "would risk disproportionately tying up the use of the underlying ideas"). As

## PUBLIC VERSION

discussed above, in this case, the inventors do not claim to be the first to make a PDC by sintering a catalyst with diamond particles in a press under high-temperature, high-pressure conditions. The discovery described in the patents here is far narrower—that using existing machinery to sinter diamond particles at a pressure of at least about 7.5 GPa may result in PDCs that achieve certain performance measures and desired magnetic and electrical properties. USS’s contribution does not allow it to monopolize every potential structure or way of creating PDCs with the claimed characteristics.

In sum, the Commission finds the asserted claims are directed to the abstract idea of stronger PDCs that achieve the claimed performance measures and desired magnetic and electrical results no matter how implemented.

## 2. *Alice* Step Two

The ID found that the claims also fail *Alice* step two because they “invoke[] well-understood, routine, [and] conventional components to apply the abstract idea[s]” recited in the claims. ID at 110. The ID found the “claims here recite several structural limitations (a polycrystalline table, an unleached portion, a plurality of diamond grains, a catalyst, and a substrate) that are generic to all PDCs.” *Id.* at 109. The ID stated that “[w]hile the inventors may have discovered methods of manufacturing PDCs that have the specific improved properties claimed,” they failed “to recite structures, methods [*e.g.*, the manufacturing steps], or any other inventive feature to achieve the objectionable claimed limitations (G-Ratio, thermal stability, electrical and magnetic parameters).” *Id.* The ID reasoned that “the claims read on any PDC structure that achieves the claimed improvements” and this “mismatch between the specification” and “the breadth of claim 1 underscores that the focus of the claimed advance is the abstract idea and not the particular configuration discussed in the specification that allegedly departs from the prior art.” *Id.* at 110.

## PUBLIC VERSION

We agree with the ID’s analysis of *Alice* step two. The elements of the asserted claims—individually and as an ordered combination—do not transform the nature of the claims into something patent-eligible. As explained above, the claims recite results-oriented language and the recited physical elements are conventional. *See* Compl. Reply Sub. at 26-27 (citing Resp. Sub. at 27-28) (not disputing the following limitations of claim 1 of the ’565 patent are conventional: “polycrystalline diamond compact,” “an unleached portion of the polycrystalline diamond table,” “a plurality of diamond grains directedly bonded together via diamond-to-diamond bonding to define interstitial regions, the plurality of diamond grains exhibiting an average grain size of about 50  $\mu\text{m}$  or less,” “a catalyst occupying at least a portion of the interstitial regions,” and “a substrate bonded to the polycrystalline diamond table.”); *see also* Resp. Sub. at 28-30. Thus, the claims do not include some “additional feature” or “inventive concept” showing that it is “more than a drafting effort designed to monopolize the” abstract idea. *ChargePoint*, 920 F.3d at 773; *Alice*, 573 U.S. at 221.

USS argues the asserted claims contain “an inventive concept” based only on the claimed properties of the PDC. *See* Compl. Sub. at 28-29. These properties are the only thing that USS puts forward as non-conventional. But, as discussed above, achieving the claimed properties is abstract because they effectively cover any PDCs with those properties no matter how it is made and, therefore, they do not qualify as an “inventive concept.” Thus, the Commission finds there is nothing “significantly more” to the claims than the abstract idea cloaked in physical elements. *Bascom Glob. Internet Servs., Inc. v. AT&T Mobility LLC*, 827 F.3d 1341, 1349 (Fed. Cir. 2016) (stating this allegedly inventive concept “cannot simply be an instruction to implement or apply the abstract idea” and “must be significantly more than the abstract idea itself”).

**SUBJECT TO PROTECTIVE ORDER**  
**PUBLIC VERSION**

In view of the above, the Commission affirms with modified reasoning the ID’s finding that the asserted claims of the ’502, ’565, and ’306 patents are directed to ineligible subject matter under § 101.

**B. The Asserted Claims of the ’565 Patent Are Invalid Under 35 U.S.C. § 102(b) by the Sale of the [REDACTED] Product**

A patent is invalid under § 102(b) (pre-AIA<sup>15</sup>) if “the invention was . . . on sale in this country, more than one year prior to the date of the application for patent in the United States.” *Abbott Labs. v. Geneva Pharms., Inc.*, 182 F.3d 1315, 1318 (Fed. Cir. 1999). A two-prong test governs the application of the on-sale bar: “First, the product must be the subject of a commercial offer for sale. . . . Second, the invention must be ready for patenting.” *Pfaff v. Wells Elecs., Inc.*, 525 U.S. 55, 67 (1998). USS does not dispute that the [REDACTED] product was on sale in this country by April 2008 and was ready for patenting at that time. *See* ID at 110; Compl. Pet. at 40. USS also does not dispute that the [REDACTED] product was a commercial “PCD cutter product” embodying each and every limitation of the asserted claims of the ’565 patent. ID at 110 (citing JX-0400C.2-.3; CX-2385C; JX-0034C.179).

The parties dispute whether the [REDACTED] was on sale more than one year before the effective filing date of the ’565 patent, *i.e.*, the critical date for the on-sale bar. “The significance of the critical date is that a sale of the invention before that date can be invalidating.” *Helsinn Healthcare S.A. v. Teva Pharms. USA, Inc.*, 855 F.3d 1356, 1360 (Fed. Cir. 2017), *aff’d*, 139 S.Ct. 628 (2019). The ’565 patent is a continuation of the ’881 patent, filed on June 1, 2012.

<sup>15</sup> The Leahy–Smith America Invents Act (“AIA”) changed 35 U.S.C. § 102. Pub. L. No. 112-29, § 3(b), 125 Stat. 284, 285-86 (2011). However, because the applications from which the Asserted Patents issued have never contained a claim having an effective filing date on or after March 16, 2013, the pre-AIA version of § 102 applies. *Id.* § 3(n)(1), 125 Stat. at 293.

The '881 patent claims priority to U.S. Patent No. 7,866,418 (“the '418 patent”; JX-0365), filed on October 3, 2008, through a chain of continuing applications, as shown below.

### Priority Date of '565 Patent

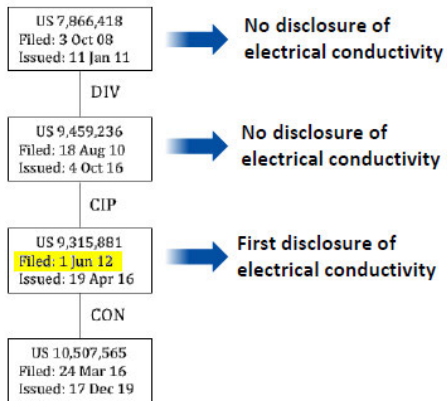

RDX-0006C.95. Any claim in a continuation-in-part application which is directed *solely* to subject matter adequately disclosed under 35 U.S.C. § 112 in the parent application is entitled to the benefit of the filing date of the parent application. If the '565 patent is entitled to claim priority to the '418 patent, then USS contends the critical date for the on-sale bar is October 3, 2007, one year before the filing date of the '418 patent, and the sale of the [REDACTED] product in 2008 does not invalidate the asserted claims of the '565 patent.<sup>16</sup>

However, if a claim in a continuation-in-part application recites a feature that was not disclosed or adequately supported under 35 U.S.C. § 112 in the parent application, but which was first introduced or adequately supported in the continuation-in-part application, such a claim is entitled only to the filing date of the continuation-in-part application, which in this case is June

<sup>16</sup> The parties do not dispute that the '502 patent is entitled to the October 3, 2008 priority date of the '418 patent and, therefore, the [REDACTED] product does not qualify as prior art to the asserted claims of the '502 patent. *See* ID at 135.

## PUBLIC VERSION

1, 2012. *See, e.g., In re Chu*, 66 F.3d 292 (Fed. Cir. 1995). The ID found the '565 patent could not claim priority to the '418 patent because the '418 patent failed to disclose a PDC with “an average electrical conductivity of less than about 1200 S/m,” as required by the asserted claims of the '565 patent. ID at 97. The ID found the first disclosure of electrical conductivity is in the '881 patent, filed on June 1, 2012, and, therefore, the critical date for the on-sale bar is June 1, 2011. On review, the Commission affirms with modified reasoning the ID’s findings that the asserted claims of the '565 patent are not entitled to the priority date of the '418 patent and, thus, those claims are invalid under § 102(b) because the claimed invention was sold prior to the critical date of June 1, 2011.

The '565 patent specification includes numerous descriptions of electrical conductivity that are found nowhere in the earlier filed '418 patent. Tr. (Barron) at 700:6-701:22. The table below provides example paragraphs highlighting the new disclosures:

	The '236 Patent and the '418 Patent	The '881 Patent and/or the '565 Patent
Detailed Description	According to various embodiments, PCD sintered at a pressure of at least about 7.5 GPa may exhibit a coercivity of 115 Oe or more, a high-degree of diamond-to-diamond bonding, a specific magnetic saturation of about 15 G-cm <sup>3</sup> /g or less, and a metal-solvent catalyst content of about 7.5 weight % (“wt %”) or less. The PCD includes a plurality of diamond grains directly bonded together via diamond-to-diamond bonding to define a plurality of interstitial regions.	According to various embodiments, unleached PCD sintered at a pressure of at least about 7.5 GPa may exhibit a coercivity of 115 Oe or more, a high-degree of diamond-to-diamond bonding, a specific magnetic saturation of about 15 G-cm <sup>3</sup> /g or less, a metal-solvent catalyst content of about 7.5 weight % (“wt %”) or less, <b>an electrical conductivity of less than about 1200 S/m, or combinations thereof</b> . The PCD includes a plurality of diamond grains directly bonded together via diamond-to-diamond bonding to define a plurality of interstitial regions.
Detailed Description	Generally, as the sintering pressure that is used to form the PCD increases, the coercivity may increase and the magnetic saturation may decrease. The PCD defined collectively by the bonded diamond grains and the metal-solvent catalyst may exhibit a coercivity of about 115 Oe or more and a metal-solvent catalyst content of less than about 7.5 wt % as indicated by a specific magnetic saturation of about 15 G-cm <sup>3</sup> /g or less.	Generally, as the sintering pressure that is used to form the PCD increases, the coercivity may increase while the magnetic saturation <b>and electrical conductivity</b> may decrease. The PCD defined collectively by the bonded diamond grains and the metal-solvent catalyst may exhibit <b>one or more of the following properties</b> : a coercivity of about 115 Oe or more, a metal-solvent catalyst content of less than about 7.5 wt % as indicated by a specific magnetic saturation of about 15 G-cm <sup>3</sup> /g or less, <b>or an electrical conductivity less than about 1200 S/m. For example, the electrical conductivity may be an average electrical conductivity of the PCD (e.g., a PCD table) or a region of the PCD.</b>

RDX-0006C.96. The '565 patent also includes teachings regarding the correlation between higher cobalt content and increased electrical conductivity properties of PCDs that are not found in the '418 patent.

PUBLIC VERSION

As shown in Tables I, III, and IV, the conventional PCD tables of Tables III and IV exhibit a higher cobalt content therein than the PCD tables listed in Table I as indicated by the relatively higher specific magnetic saturation values. This is believed by the inventors to be a result of the PCD tables listed in Tables III and IV being formed by sintering diamond particles having a relatively greater percentage of fine diamond particles than the diamond particle formulations used to fabricate the PCD tables listed in Table I.

Embodiments of Applications for PCD and PDCs

'418 patent, 15:51-61.

As shown in Tables I, III, and IV, the conventional PCD tables of Tables III and IV exhibit a higher cobalt content therein than the PCD tables listed in Table I as indicated by the relatively higher specific magnetic saturation values. This is believed by the inventors to be a result of the PCD tables listed in Tables III and IV being formed by sintering diamond particles having a relatively greater percentage of fine diamond particles than the diamond particle formulations used to fabricate the PCD tables listed in Table I.

A similar correlation between higher cobalt content and increased electrical conductivity properties of PCD tables has also been observed. Sensitivity of electrical conductivity measurements of PDC diamond tables of a given PCD microstructure may provide an excellent method for estimation and imaging of metal content in the diamond table. Such types of estimates are sensitive to changes in bulk average metal-solvent content and local changes in the metal-solvent content, allowing for a sensitive estimation of both metal content and cutting performance.

Referring back to FIGS. 9 and 10, electrical conductivity trends with metal-solvent content suggest that lowering the metal-solvent content, and thus the electrical conductivity, increases performance of a PDC. In fact, relatively lowered metal-solvent content in the PDC appears to substantially influence cutting performance. Therefore, it follows that the electrical conductivity, also dependent on metal-solvent catalyst content, may also be used as a quality characteristic for evaluating PDC cutting performance. For example, a PCD cutting element with electrical conductivities below about 1200 S/m (in an unleached region of PCD) have been found to increase cutting performance.

Embodiments of Applications for PCD and PDCs

'565 patent, 22:33-64.

The '565 patent further includes five figures related to electrical conductivity that are not found in the earlier '418 patent.

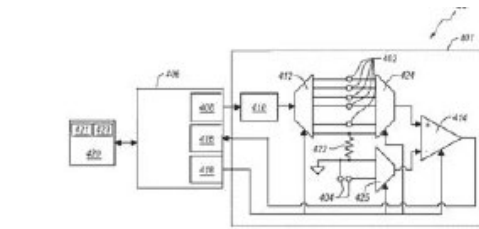

FIG. 3B

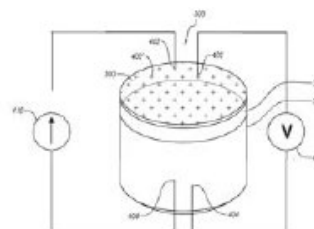

FIG. 4

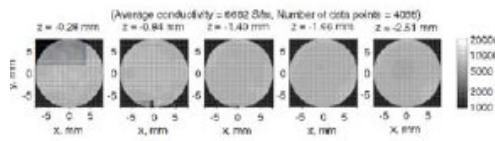

FIG. 7A

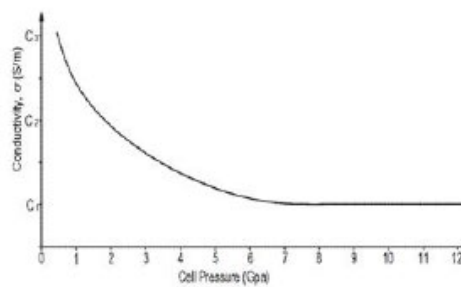

FIG. 9

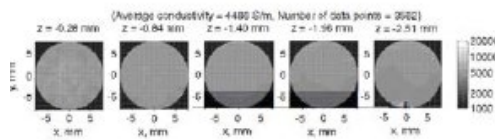

FIG. 7B

JX-0002

RDX-0006C.97. The Commission finds the '565 patent's extensive disclosures about electrical conductivity that are not found in the '418 patent suggest the inventors believed that they were

## PUBLIC VERSION

adding new matter to the '881 and '565 patents with the teachings regarding electrical conductivity.

Nonetheless, USS asserts the '565 patent claims are entitled to the earlier filing date of the '418 patent, October 3, 2008, on the grounds that the '418 patent inherently discloses the electrical conductivity limitation. The Commission disagrees. “Under the doctrine of inherent disclosure, when a specification describes an invention that has certain undisclosed yet inherent properties, that specification serves as adequate written description to support a subsequent patent application that explicitly recites the invention’s inherent properties.” *Yeda Rsch. & Dev. Co. v. Abbott GMBH & Co. KG*, 837 F.3d 1341, 1345 (Fed. Cir. 2016). For a disclosure to be inherent, “the missing descriptive matter must *necessarily* be present in the parent application’s specification such that one skilled in the art would recognize such a disclosure.” *Tronzo v. Biomet, Inc.*, 156 F.3d 1154, 1159 (Fed. Cir. 1998) (emphasis added).

USS asserts that the '418 and '565 patents disclose the exact same working examples in Table I, made using the same disclosed fabrication method. *See* ID at 98; Compl. Sub. at 32-33. USS argues that since the '565 patent discloses that all of the example PDCs in Table I exhibit an average electrical conductivity of less than about 1200 S/m and PDCs made under the same manufacturing conditions and input materials exhibit the same electrical conductivity, then the same examples in the '418 patent necessarily exhibit an average electrical conductivity of less than about 1200 S/m. *See* Compl. Sub. at 32-33. The Commission finds the ID erred in finding that the '418 and '565 patents do not disclose the same working examples in Table I. However, this error does not change the fact that the record evidence shows that the examples in Table I do not necessarily have an average electrical conductivity that is less than about 1200 S/m.



## PUBLIC VERSION

The ID erred by finding that USS has not shown that the '418 patent “adequately teaches the same starting materials and the same manufacturing conditions” for the example PDCs in Table I. ID at 98. While the '418 and '565 patent disclosures do not expressly disclose all sintering conditions used to manufacture the PDCs in Table I, as the ID found, there is no reason to believe that the PDCs in Table I are not the same in both patents. The magnetic properties of the PDC tables are exactly the same and the descriptions of Table I are nearly verbatim in both patents. *Compare* '418 patent (JX-0365) at 16:55-17:20 (Tbl. I) *with* '565 patent at 20:15-37 (Tbl. I). Indeed, Respondents do not dispute that “the 418 Patent and the 565 Patent describe the same working examples.” Resp. Reply Post-Hearing Br. at 69; *see also* Resp. Reply at 37 (“[I]t is true that the '418 Patent and the '565 Patent describe the same working examples and the same fabrication methods.”).

However, even if the PDCs disclosed in Table I of both patents are the same, nowhere does the '565 patent disclose that any of the examples in Table I necessarily exhibit an average electrical conductivity of less than about 1200 S/m. The '565 patent states that certain unspecified disclosed embodiments may result in a PDC having an electrical conductivity of less than about 1200 S/m. *See, e.g.*, '565 patent at 5:64-6:10 (“The PCD defined collectively by the bonded diamond grains and the metal-solvent catalyst *may exhibit* one or more of the following properties . . . *an electrical conductivity less than about 1200 S/m.*” (emphasis added)). USS asserts that “the '565 patent presents Table I, which provides ‘detail[s] about the magnetic properties of PCD tables of PDCs fabricated in accordance with the principles of *some* of the specific embodiments of the invention (i.e., PDCs having an average electrical conductivity of less than about 1200 S/m).” Compl. Sub. at 32 (emphasis added) (citing '565 patent at 19:1-4; Abstract). The '565 patent at column 19, lines 49-51, states that “Table I below lists PCD tables

## PUBLIC VERSION

that were fabricated in accordance with the principles of *certain* embodiments of the invention discussed above” (emphasis added), but electrical conductivity is not a property listed in the table and there is no indication that the examples in Table I necessarily exhibit the claimed electrical conductivity parameter.

Indeed, in response to the Commission’s question asking whether the ’418 and the ’565 patents disclose, either expressly or inherently, an exemplary PDC exhibiting “an average electrical conductivity of less than about 1200 S/m,” USS admits the examples in Table I of the ’565 patent do not expressly disclose the average electrical conductivity values but argues “that is unnecessary because the specification makes clear that PCDs manufactured using specific input materials under specific manufacturing conditions produce PDCs having the claimed electrical conductivity values.” Compl. Reply Sub. at 28; *see* Compl. Sub. at 31, 32-33 (asserting the samples in Table I of the ’565 patent disclose the claimed electrical conductivity but pointing only to claim 1, the Abstract, and certain manufacturing methods) (citing ’565 patent at Abstract, 19:1-4, 19:51-54, 20:4-6). However, USS also admits that the ’418 patent specification “discloses ranges of manufacturing parameters,” and that a person of ordinary skill in the art (“POSITA”) would have “to select appropriate numbers within those ranges to arrive at the claimed PDCs, in light of the specific working examples.” Compl. Reply Sub. at 29; *see* ’565 patent at 12:20-13:26 (describing ranges for sintering pressure, temperature, input diamond particle size, etc.). USS does not explain why a POSITA would necessarily choose parameters to achieve an average electrical conductivity of less than 1200 S/m, particularly given that electrical conductivity is not listed in Table I and not discussed anywhere in the ’418 patent specification.

USS relies on Dr. German’s testimony in an attempt to fill in the gaps. USS submits that Dr. German testified that the sample PCDs of Table I in the ’418 patent inherently exhibit the

## PUBLIC VERSION

claimed electrical conductivity. Compl. Sub. at 35 (citing Tr. (German) at 1245:2-1247:25). Every PDC may have a measurable electrical conductivity due to the presence of cobalt or other metal catalyst, but that does not mean the PDCs necessarily have an average electrical conductivity of less than 1200 S/m. See Tr. (Barron) at 747:2-5 (agreeing that “a polycrystalline diamond table that contains cobalt will have some electrical conductivity as a property”). As the ID noted, Dr. German never actually measured the electrical conductivity of the samples listed in Table I. Rather, he based his opinion solely on the ’418 patent’s disclosure regarding the cobalt content of the samples. See Compl. Sub. at 43 (“Dr. German consistently explained that the average electrical conductivity of a PDC reflects the PDC’s microstructure, such as the amount of cobalt in a PDC, which is determined by the input materials and manufacturing methods used to produce it.”); Tr. (German) at 1245:22-1246:6. However, the ID found Dr. German’s testimony unreliable because “there is no disclosure of actual cobalt concentration [since] the concentrations given in Table I are simply the specific magnetic saturation measurements divided by 2.01,” and it found the 2.01 proportionality constant “is not a clearly reliable measure of cobalt concentration.” ID at 99. The Commission did not review this finding in the ID, *id.* at 94-95, and thus agrees that Dr. German’s opinion based on the cobalt content of the samples is unreliable. Moreover, as the ID found, Dr. German’s opinion conflicts with his previous testimony during the hearing. *Id.* at 99;<sup>17</sup> Tr. (German) at 364:21-365:6, 365:18-366:3, 366:8-

<sup>17</sup> The ID (at 99) cites to Dr. German’s testimony that “when [a PDC is] leached, the electrical conductivity drops down.” ID at 99 (quoting Tr. (German) at 128:14-129:21). USS argues “this is not relevant to the electrical conductivity of the PDCs disclosed in the ’418 Patent, *which are not leached.*” Compl. Pet. at 46. The Commission finds Dr. German’s testimony irrelevant and potentially confusing because the ’565 patent claims require “the *unleached* portion of the polycrystalline diamond table exhibits an average electrical conductivity of less than about 1200 S/m” and the ’565 patent specification discloses that “a PCD cutting element with electrical conductivities below about 1200 S/m (in an *unleached*

## PUBLIC VERSION

367:2 (testifying that despite having detailed manufacturing information about certain products, Dr. German could not determine whether the products met the claim limitations, including the electrical conductivity limitation, unless he tested those products). In sum, the Commission finds that Dr. German's testimony regarding the inherent disclosure of the average electrical conductivity parameter in the '418 patent is unreliable.

USS also submits that Respondents' expert, Dr. Barron, does not dispute that the PDC examples in Table I of the '418 patent inherently disclose the claimed average electrical conductivity. Dr. Barron's opinion was based on his belief that the only thing a POSITA needs to know to predict the electrical conductivity is the percentage of cobalt by weight. Tr. (Barron) at 747:21-25, 749:7-13; *see* RDX-0006C.68-72. In particular, Dr. Barron testified that "any PDC that has a cobalt percentage less than 25 percent cobalt by weight will have an electrical conductivity of less than 1200 siemens per meter." Tr. (Barron) at 749:7-13. Dr. Barron's model was based on teachings from prior art references, including Akaishi. *See* ID at 96-97 (citing Tr. (Barron) at 681:18-684:4); Resp. Reply Sub. at 38. The Commission did not review the ID's finding that Akaishi does not disclose the same manufacturing conditions and input materials as the '418 and '565 patents, ID at 96-97, 118-19, and, thus, Dr. Barron's model based on the prior art is not a reliable measure of the average electrical conductivity of PDCs manufactured according to the embodiments disclosed in the '418 and '565 patents.

Moreover, as with Dr. German's opinion, the Commission agrees with the ID's finding that Dr. Barron's model for electrical conductivity is "conclusively refuted by Dr. German's testing" (discussed below). ID at 97 (citing CX-0383C). Specifically, the Commission agrees

region of PCD) have been found to increase cutting performance." '565 patent at 22:60-62 (emphasis added). Thus, the Commission determines to strike this citation in the ID.

PUBLIC VERSION

with the ID’s finding that Dr. German’s actual testing of the domestic industry products and accused products show that the sample PCDs of Table I in the ’418 patent do not necessarily exhibit the claimed electrical conductivity. *Id.* In particular, the ID found that the “cobalt concentration of every tested sample was significantly less than 20 weight percent, but dozens of samples displayed a conductivity exceeding 1200 S/m, in some cases by wide margins.” *Id.* (citing CX-0383C.07 (Juxin 1613 CT200 (BBBBA.03) had [REDACTED] cobalt and electrical conductivity of [REDACTED]).

USS argues that the ID’s finding regarding Dr. German’s testing “is premised on a false equivalence between the incomplete manufacturing information provided by Respondents and the ’418 patent’s and ’565 patent’s more complete disclosures.” Compl. Reply Sub. at 32. Yet, the ID found the ’418 patent fails to disclose input materials and manufacturing conditions “particularly relevant for electrical conductivity,” including the “sintering time at any particular pressure/temperature combination” and “the cobalt concentration in the tungsten carbide substrate.” ID at 98-99. While certain Respondents did not provide all relevant manufacturing parameters for their accused products, neither did USS. *Id.* at 100 (finding “USS does not identify the sintering pressures and temperatures” for its DI Products). And even where Respondents reported manufacturing parameters that are “particularly complete” and “show a striking consistency (namely, identical sintering pressure and temperature, relatively low grain size, and relatively high cobalt concentration)” as the manufacturing conditions disclosed in the ’418 patent, “their electrical conductivities vary between [REDACTED] [REDACTED]” *Id.* (citing CX-0383C.2-.3); *see also* Tr. (German) at 365:10-366:22 (testifying [REDACTED] products have the same starting materials and manufacturing

PUBLIC VERSION

processes, but despite having the same manufacturing information, certain samples were below 1200 S/m and others were above the threshold).

Moreover, USS does not refute the ID's finding that "[t]hree of the four DI Products consistently exhibit electrical conductivity below 1200 S/m, but their input diamond particle sizes are significantly larger than specified in the 418 patent," and the "fourth DI Product, the [REDACTED], does not consistently exhibit electrical conductivity below 1200 S/m, even though it has the same input diamond particle size as the [REDACTED] and approximately the same cobalt concentration." ID at 99 (CX-0383C.2; CX-2141C ([REDACTED] specification); CX-2142C ([REDACTED] specification); CX-2143C ([REDACTED] specification); CX-2144C); *see* Resp. Reply Sub. at 31 (explaining that different samples of [REDACTED] have "electrical conductivity values that ranged from 903 S/m (less than about 1200 S/m) to 1513 S/m (much greater than about 1200 S/m)"). Accordingly, the Commission finds the record evidence does not support USS's inherency argument and agrees with the ID that "it cannot be concluded that the '418 patent discloses even a single [PDC] example that necessarily possesses an electrical conductivity of 1200 S/m or below." ID at 100.

Contrary to USS's argument, this case is not analogous to *Kennecott Corp. v. Kyocera Int'l, Inc.*, 835 F.2d 1419 (Fed. Cir. 1987). In that case, the defendants had conceded the claim limitation at issue in the asserted '299 patent was inherently disclosed in the parent '954 application:

In this case, the invention of the '299 claims is a ceramic product. That product is the same as the product in the '954 application, and has the same structure. It was conceded that anyone with a microscope would see the microstructure of the product of the '954 application. The disclosure in a subsequent patent application of an inherent property of a product does not deprive that product of the benefit of an earlier filing date.

**SUBJECT TO PROTECTIVE ORDER**  
**PUBLIC VERSION**

*Id.* at 1423. As discussed above, although USS asserts that both parties' experts testified that the '418 patent inherently discloses the electrical conductivity limitation, the ID found both experts' testimonies were unreliable and contradicted other testimony and test data. The Commission agrees with the ID's assessment of the record on this point.

The Commission finds that the record evidence does not support USS's argument that the '418 patent inherently discloses that the examples necessarily have an average electrical conductivity of less than 1200 S/m. The Commission affirms with the above modified reasoning the ID's findings that the asserted claims of the '565 patent are not entitled to the priority date of the '418 patent but rather have a priority date of June 1, 2012. USS does not dispute that the [REDACTED] product meets all of the limitations of the asserted claims of the '565 patent, and that at least one was sold in April 2008. ID at 110 (citing JX-0400C.2-.3; CX-2385C; JX-0034C.179). Accordingly, the Commission finds that a product meeting all the limitations of the asserted claims of the '565 patent was on sale more than one year before the effective filing date of the '565 patent and therefore the asserted claims of the '565 patent are invalid under § 102(b).

**C. Respondents Have Not Shown That the Mercury PDC Anticipates Claims 1 and 2 of the '565 Patent and Claims 1 and 11 of the '502 Patent**

Respondents contend that the Mercury PDC, which was manufactured by third-party Diamond Innovations and produced pursuant to subpoena, was "known or used by others in this country" prior to the date of invention of the '565 and '502 patents under pre-AIA 35 U.S.C. § 102(a) and, therefore, anticipates claims 1 and 2 of the '565 patent and claims 1 and 11 of the '502 patent. The Commission finds that the record evidence supports the ID's finding that the Mercury PDC tested by Respondents' expert, Mr. Bellin, meets all the limitations of claims 1 and 2 of the '565 patent and claims 1 and 11 of the '502 patent. Respondents, however, failed to establish by clear and convincing evidence that the Mercury PDC is prior art to the '565

SUBJECT TO PROTECTIVE ORDER

PUBLIC VERSION

and '502 patents under § 102(a) (pre-AIA), and thus, the Commission reverses the ID's finding that the Mercury PDC anticipates claims 1 and 2 of the '565 patent and claims 1 and 11 of the '502 patent.

An article qualifies as prior art if it was “known or used by others in this country . . . before the invention thereof by the applicant for patent.” 35 U.S.C. § 102(a) (pre-AIA). The Federal Circuit has interpreted the “known or used” prong of § 102(a) to mean “knowledge or use which is accessible to the public.” *BASF Corp. v. SNF Holding Co.*, 955 F.3d 958, 964 (Fed. Cir. 2020). Since the parties do not dispute that the date of invention for the asserted claims of the '502 and '565 patents is January 4, 2008, we assume this date for the purpose of our analysis of this issue. *See* ID at 111; JX-0034C.179. Thus, Respondents must show that the Mercury PDC was made publicly available before January 4, 2008 to succeed in its argument.

Respondents assert that a letter from Diamond Innovations' counsel (“the Brinkman Letter,” RX-0554C) accompanying the production of the Mercury 1613 samples tested by Mr. Bellin establishes the Mercury PDC was publicly available before January 2008. Resp. Sub. at 57. The Brinkman Letter states that the Mercury 1613 sample is one of [REDACTED] [REDACTED] RX-0554C.003. The letter includes information that Diamond Innovations' witness, Mr. Gledhill, personally retrieved and other information that Mr. Gledhill obtained by a staff member querying Diamond Innovations' “system.” ID at 112 (citing Tr. (Gledhill) at 530:20-531:9). According to a chart (reproduced below) included in the Brinkman Letter, the Mercury 1613 was [REDACTED] [REDACTED]. *Id.*; *see* Tr. (Gledhill) at 534:24-535:2.



SUBJECT TO PROTECTIVE ORDER

PUBLIC VERSION

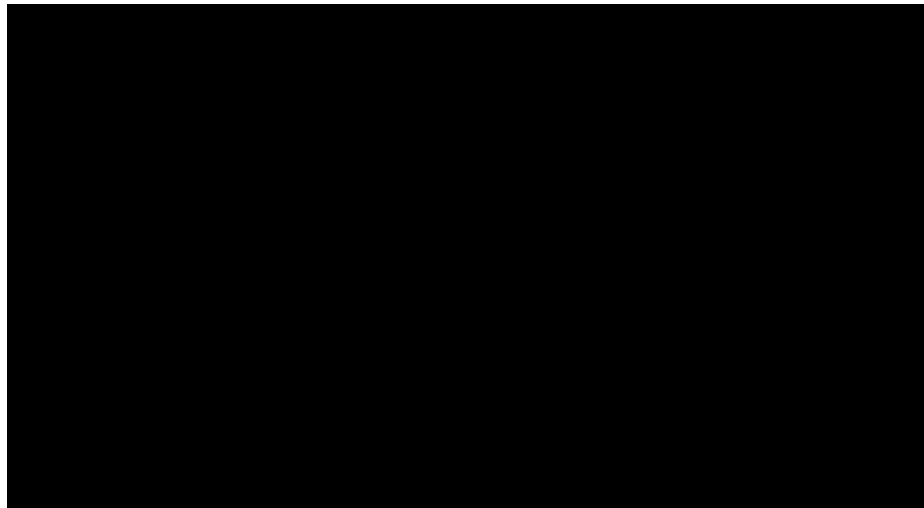

Resp. Sub. at 62 (citing RX-0554C.3 (annotated)). Even assuming the information in the chart is reliable, the Commission finds it does not establish the Mercury PDC was publicly available before January 2008, because it is not clear [REDACTED] or whether the Mercury **1613** was sold or otherwise made available to the public before January 2008.

Respondents assert that the Brinkman Letter is corroborated by USS' own testing of a Mercury **1608** prior to October 2008 and the trial testimony of Mr. Gledhill.<sup>18</sup> The ID appears to assume the Mercury **1608** and Mercury **1613** are identical for all relevant purposes and found it "reasonable to infer that as a competitor of Diamond Innovations, USS obtained [a Mercury **1608**] by a purchase prior to October 2008." ID at 112 (citing Tr. (Bertagnolli) at 101:10-102:22; JX-0370C.62; *see also* JX-0517C (Mukhopadhyay Dep. Tr.) at 96:4-16). However, Dr. Bertagnolli testified that he did not know how USS obtained the Mercury **1608** sample for testing. Tr. (Bertagnolli) at 101:10-102:22. Moreover, Mr. Gledhill could not find any evidence that the Mercury **1613** was sold or otherwise made available to the public at any time, let alone prior to the date of the invention. *See* Tr. (Gledhill) at 535:6-14, 536:13-15. Even if USS

<sup>18</sup> Mr. Gledhill's Declaration was stricken because it was produced eleven days after the close of fact discovery, as discussed below. *See* Order No. 48 (Oct. 14, 2021).

## PUBLIC VERSION

purchased a Mercury **1608** prior to October 2008, the evidence does not establish public availability of either Mercury PDC before January 2008, the date of the invention under § 102(a).

Moreover, USS argues the “ID erroneously mixed and matched the evidence concerning . . . one product (Mercury 1608) and the evidence concerning how a different product (Mercury 1613) practiced the claim elements.” Compl. Reply Sub. at 45-46. Respondents contend that Mercury **1608** has the same PDC table and, thus, exhibits the same properties, as the Mercury **1613**. Resp. Reply Sub. at 45-46 (citing Tr. (Bellin) at 1005:15-1006:20 (testifying that between the Mercury **1608** and **1613**, the “diamond tables are usually the same height” and “[o]nly the carbide, the substrate changes, its length”); Tr. (Bertagnolli) at 107:7-23 (explaining that PDCs are named using this four-digit number, where the “first two numbers refer to the diameter in millimeters” of the PDC, and the “second two numbers refer to the height in millimeters” of the PDC)). The Commission finds that Respondents’ argument conflicts with statements they made in their motion to compel USS to produce the Mercury **1608**. In their motion, Respondents argued the two PDCs “are different products.” Resp. Mot. to Compel<sup>19</sup> at 4 n.3 (“Diamond Innovations only produced a Mercury 1613 sample, not a Mercury 1608 sample. These are different products that exhibit different characteristics, and thus are not duplicative.”).

USS does not dispute Mr. Bellin’s and Dr. Bertagnolli’s testimonies regarding the PDC industry’s naming convention, but argues that “it is common practice in the PDC industry to make a variety of different products under the same product name” and to “make new

<sup>19</sup> Respondents’ Motion to Compel, EDIS Doc ID 746382 (Jul. 7, 2021) (“Resp. Mot. to Compel”).

SUBJECT TO PROTECTIVE ORDER  
PUBLIC VERSION

experimental products, assign them new product designations under an existing brand name, and test them for internal research and development purposes, without ever selling them or otherwise disclosing it to the public.” Compl. Reply Sub. at 47. The evidence is unclear as to whether the two PDCs would exhibit the same properties. Since the burden falls on Respondents, the Commission finds Respondents failed to show by clear and convincing evidence that the Mercury **1608** and Mercury **1613** would exhibit the same properties. *See Intel Corp. v. U.S. Int’l Trade Comm’n*, 946 F.2d 821, 830 (Fed. Cir. 1991). Therefore, the information regarding the Mercury **1613** in the Brinkman Letter, even when considered in light of USS’s testing of a Mercury **1608** prior to October 2008, is not sufficient to prove that the Mercury PDC was publicly available before January 2008.<sup>20</sup>

Mr. Gledhill testified regarding the meaning of [REDACTED]  
[REDACTED] in the Brinkman letter, and Diamond Innovation’s historical PDC [REDACTED]  
[REDACTED] See Tr. (Gledhill) at 530:7-19 (explaining that [REDACTED]  
[REDACTED]  
[REDACTED] (emphasis added), 532:8-24  
(testifying that [REDACTED]  
[REDACTED]  
532:25-533:8 (explaining that [REDACTED]  
[REDACTED]  
[REDACTED]

<sup>20</sup> Respondents also cite to Mr. Bellin’s testimony that he tested Mercury PDCs when he worked at Varel, but Mr. Bellin did not join Varel until 2009, which is after the January 2008 date of invention. Resp. Sub. at 64 (citing Tr. (Bellin) at 956:5-13); Tr. (Bellin) at 1013:14-16.

SUBJECT TO PROTECTIVE ORDER  
PUBLIC VERSION

Although Respondents assert that Mr. Gledhill’s testimony supports finding the Mercury **1613** was commercially available and exhibits the same properties as the Mercury **1608**, the Commission finds the above-cited portions of Mr. Gledhill’s testimony should be stricken in view of the ALJ’s rulings in Order No. 48 and at trial. By way of background, the Brinkman Letter and the Mercury **1613** samples were produced on May 19, 2021. Compl. MIL<sup>21</sup> at 1. On June 28, 2021, the last day of fact discovery and the last day to supplement their invalidity contentions, Respondents served invalidity contention charts that asserted invalidity based on the Mercury PDC. *Id.* The charts relied on the Brinkman Letter and made references to a Diamond Innovations’ written declaration, which had not yet been produced. *Id.* On July 2, 2021, USS informed Respondents that no declaration was produced. *Id.* at 2. On July 9, 2021, eleven days after the close of fact discovery, Respondents served a declaration from Mr. Gledhill. *See* Doc ID 752820, Ex. 1 (Gledhill Decl.). The declaration contained new information regarding the Mars and Mercury PDCs that was not previously disclosed during fact discovery. Order No. 48 at 2-3. In particular, Mr. Gledhill’s declaration purported to explain manufacturing practices at Diamond Innovations prior to his employment and the [REDACTED] [REDACTED] that Respondents received from Diamond Innovations in this investigation. *Id.* USS filed a motion *in limine* to exclude Mr. Gledhill’s written declaration, which was granted by the ALJ in Order No. 48. *Id.* at 2-4. Order No. 48 excluded the Gledhill Declaration, which “(1) stated [REDACTED] [REDACTED] [REDACTED]

<sup>21</sup> *See* Complainant’s Motion *in Limine* No. 3 to Exclude the Declaration of Andrew Gledhill, EDIS No. 752820 (Sep. 28, 2021) (“Compl. MIL”).

SUBJECT TO PROTECTIVE ORDER

PUBLIC VERSION

[REDACTED]

[REDACTED]

[REDACTED]

[REDACTED]

[REDACTED]

[REDACTED]

[REDACTED]

[REDACTED] Order No. 48 at 3.

Although his declaration was excluded, the ALJ permitted Mr. Gledhill to testify at the hearing regarding information contained in the Brinkmann Letter. The ALJ excluded Mr. Gledhill's testimony that was outside the scope of the Brinkmann Letter except information such as his background, the nature of Diamond Innovations' business, and document authentication. Tr. at 669:13-24. The ALJ instructed the parties to submit proposed redactions to the transcript when they submitted their post-hearing briefs. *Id.* at 1112:5-22.

After the evidentiary hearing, the parties met and conferred regarding proposed redactions of Mr. Gledhill's hearing testimony. The ALJ did not rule on the parties' proposed redactions. The parties agreed that the following portions of Mr. Gledhill's testimony would be stricken: Tr. at 527:17-528:9, 533:9-534:3, 534:7-23. *See* EDIS Doc ID 756022 (Respondents' proposed redactions); EDIS Doc ID 756029 (Complainant's proposed redactions). USS and Respondents could not reach an agreement on the other portions of his testimony: Tr. at 522:13-16, 528:10-529:9, 529:21-530:19, 530:24-25, 532:8-533:8, and 534:4-6. The Commission finds Mr. Gledhill's testimony at Tr. 530:24-25 should not be stricken because it pertains directly to how Mr. Gledhill obtained the samples in the Brinkmann Letter. *See* ID at 112. The testimony at Tr. 522:13-16 is like the testimony at Tr. at 530:24-25 and thus should also not be stricken.

PUBLIC VERSION

The testimony at Tr. 534:4-6 should not be stricken because it relates to Mr. Gledhill's work experience at Diamond Innovations.

The other disputed portions of Mr. Gledhill's testimony should be stricken because they relate to technical information disclosed for the first time at the hearing. *See* Tr. at 671:13-672:11 (ALJ excluding technical information that is neither in the Brinkman letter nor the Gledhill Declaration). In particular, the testimony at Tr. 528:10-529:9 relates to Diamond Innovations' [REDACTED]

[REDACTED] Compl. Sub. at 44, and is similar to topic (1) stricken by Order No. 48. The testimony at Tr. 529:21-530:19 relates to Diamond Innovations' [REDACTED]

[REDACTED] and is like topic (2) stricken by Order No. 48.

The testimony at Tr. 532:8-533:8 relates to Diamond Innovations' product naming and manufacturing practices.

In short, the Commission finds that the evidence that is properly a part of the record, including the Brinkman Letter, USS's testing of a Mercury **1608** prior to October 2008, and testimony regarding the PDC industry's naming convention, is not sufficient to prove the Mercury PDC was publicly available before January 2008. The Commission therefore reverses the ID's finding that Respondents established by clear and convincing evidence that the Mercury PDC is prior art and that the Mercury PDC anticipates claims 1 and 2 of the '565 patent and claims 1 and 11 of the '502 patent under § 102(a).

**D. Respondents Have Not Shown That the Asserted Claims of the '502, '565, and '306 Patents Are Not Enabled**

The Commission affirms with modified reasoning the ID's finding that Respondents failed to provide clear and convincing evidence that the asserted claims of the '502, '565, and '306 patents are not enabled.

## PUBLIC VERSION

A patent is enabled if “at the time of filing the application one skilled in the art, having read the specification, could practice the invention without ‘undue experimentation.’” *Cephalon, Inc. v. Watson Pharms., Inc.*, 707 F.3d 1330, 1336 (Fed. Cir. 2013) (citation omitted). “Whether undue experimentation is required ‘is not a single, simple factual determination, but rather is a conclusion reached by weighing many factual considerations,” known as the *Wands* factors. *Id.* The *Wands* factors include: (1) the quantity of experimentation necessary, (2) the amount of direction or guidance presented, (3) the presence or absence of working examples, (4) the nature of the invention, (5) the state of the prior art, (6) the relative skill of those in the art, (7) the predictability or unpredictability of the art, and (8) the breadth of the claims. *Id.*

Respondents argue that the Asserted Patents failed to enable the claimed magnetic properties, electrical conductivity,  $G_{ratio}$ , and thermal stability ranges. 1<sup>st</sup> Resp. Pet. at 17. Respondents relied on the testimony of Complainant’s expert and fact witnesses. Specifically, Respondents’ evidence supporting lack of enablement was based primarily on Mr. Bertagnolli’s testimony that more manufacturing information such as “the full particle size distribution and the sintering pressure profile is needed” to predict the properties of the PDC and Dr. German’s testimony that “the only way a POSITA could ever determine whether a product met the claimed properties was to test each and every individual product.” *Id.* at 18-19 (citing JX-0350 (Bertagnolli Tr.) at 61:3-64:6, 100:7-101:4, 141:23-142:22; Tr. (German) at 366:17-368:4). Neither witness, however, opined on whether the experimentation necessary to make a PDC with the claimed properties would be unduly extensive. For that, Respondents make only attorney arguments that it would require undue experimentation to determine what processing parameters are necessary to result in the claimed properties. *See, e.g.*, 1<sup>st</sup> Resp. Pet. at 18, 20; *see also* Compl. Reply at 17.

## PUBLIC VERSION

USS asserts that the Asserted Patents disclose “detailed manufacturing information” and “working examples in Table I with a specific set of input conditions” such that a POSITA “would know how the manufacturing information disclosed in the Asserted Patents can be used to achieve the claimed PDCs.” Compl. Reply at 17-19 (citing JX-0003 at 8:26-10:15; Tr. (German) at 1272:3-1273:8). While Dr. Bertagnolli testified that the patents do not disclose the particle size distribution information for making the PCDs in Table I, he explained that the universe of possible particle size distributions is limited by the magnetic properties disclosed in Table I. Tr. (Bertagnolli) at 97:19-99:16. He also testified that a POSITA would make the disclosed PCDs in Table I through trial and error, choosing various different particle size distributions and then testing them to see if they got the reported magnetic properties. *Id.* Thus, even if the particular particle size distribution information was needed, Respondents have not shown that it would take undue experimentation for a person of ordinary skill in the art to figure that out, given the narrow set of possible particle size distributions, the other properties described in the patents, and a POSITA’s general knowledge of manufacturing PCDs. Compl. Reply at 20. The evidence also shows that “a POSITA could have easily measured these properties without any undue experimentation,” *id.* at 21, and that “it is routine practice in the industry to test PDCs after manufacturing to ensure consistent quality and performance,” *id.* at 19. In view of the evidence as a whole, the Commission finds that Respondents have not shown that a POSITA with the knowledge disclosed in the patents would require undue experimentation to make PDCs with the claimed properties. Accordingly, the Commission affirms with modified reasoning the ID’s finding that Respondents did not prove by clear and convincing evidence that the asserted claims are not enabled.



PUBLIC VERSION

**E. Domestic Industry**

In view of the Commission's finding that all asserted claims of the '502, '565, and '306 patents are directed toward ineligible subject matter and/or invalid, the Commission determines to take no position on the ID's economic prong findings, including the ALJ's determination to allow USS to supplement its contentions with a new domestic industry allocation method.

**V. CONCLUSION**

For the reasons set forth herein, the Commission determines that USS has not established a violation of section 337 by Respondents with respect to claims 1, 2, 4, 6, and 18 of the '565 patent, claims 1, 2, 11, 15, and 21 of the '502 patent, and claim 15 of the '306 patent.

Accordingly, the investigation is terminated with a finding of no violation of section 337.

By order of the Commission.

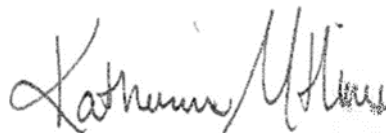

Katherine M. Hiner  
Acting Secretary to the Commission

Issued: October 26, 2022

PUBLIC VERSION

UNITED STATES INTERNATIONAL TRADE COMMISSION  
Washington, D.C.

**In the Matter of**

**CERTAIN POLYCRYSTALLINE  
DIAMOND COMPACTS AND  
ARTICLES CONTAINING SAME**

**Investigation No. 337-TA-1236**

**DISSENTING OPINION OF COMMISSIONER SCHMIDTLEIN**

This matter involves the Commission’s review of the presiding administrative law judge’s final initial determination (“ID”). The ID found no violation of section 337 by Respondents. Specifically, the ID found at least one accused product infringes all asserted claims of the asserted patents, but found all of the claims ineligible under 35 U.S.C. § 101. The ID also found a subset of the asserted claims invalid under 35 U.S.C. § 102. I join the Commission’s decision today affirming the ID’s section 102 findings as modified in the Commission’s opinion.

The section 101 findings are a different matter. The ID found the asserted claims reciting a manufactured composition of matter – a class of invention that has historically been patent eligible – ineligible for being directed to an abstract idea. In my view, the claims are directed to an eligible composition of matter – *i.e.*, polycrystalline diamond compact defined by specific, objective measurements. I therefore dissent from the Majority’s decision to affirm the ID’s section 101 findings.

Because I would reverse the ID’s section 101 findings, I would also reverse the ID’s finding of no violation in this investigation for the asserted claims that were not otherwise found invalid under section 102.

## PUBLIC VERSION

**I. PATENTED TECHNOLOGY**

The patents addressed in the ID are U.S. Patent Nos. 10,507,565 (the “’565 patent”), 10,508,502 (the “’502 patent”), and 8,616,306 (the “’306 patent”).<sup>1</sup> The patents relate to polycrystalline diamond compacts (“PDCs”), which are manufactured compositions that include polycrystalline diamond (“PCD”). PDCs are utilized in a variety of mechanical applications, including use in drilling tools, among other applications. ’565 patent (JX-0002)<sup>2</sup> at 1:21-25. According to the patents, “PDCs have found particular utility as superabrasive cutting elements in rotary drill bits.” *Id.* at 1:26-28.

A PDC cutting element typically includes a superabrasive diamond layer referred to as a polycrystalline diamond table that is bonded to a substrate. The polycrystalline diamond table is made from synthesized diamond. Figure 11A of the ’565 patent (reproduced below) depicts a PDC embodiment. *See, e.g., id.* at 15:63-16:21.

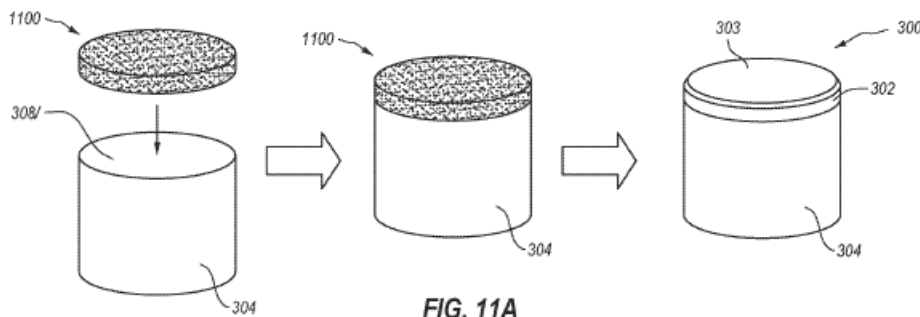

FIG. 11A

<sup>1</sup> Complainant US Synthetic Corporation (“USS”) did not petition for review of the ID’s finding of no violation with respect to the ’306 patent, including the finding that the sole asserted claim is invalid under 35 U.S.C. § 102(b). Accordingly, USS’s claim of a violation based on the ’306 patent has been abandoned. *See* 19 C.F.R. § 210.43(b)(2). Because USS has abandoned its claim of a violation based on the ’306 patent, my dissent focuses on the claims of the ’565 and ’502 patents.

<sup>2</sup> Citations are primarily to the ’565 patent. The ’502 patent provides, to a significant extent, similar disclosures as the ’565 patent. Some differences between the specifications are noted in my dissent. Any difference between the specifications do not impact the conclusion that the asserted claims of both patents are eligible.

## PUBLIC VERSION

Figure 11A of the '565 patent shows the diamond table **302**, a working surface **303** of the table **302**, and a substrate **304**. *Id.* at 1:28-30; 9:44-47; 15:62-16:10. The substrate **304** is often made from a cemented hard metal composite, like cobalt-cemented tungsten carbide. *See id.* at 6:43-45, 9:44-45, 14:44-50.

Figures 13 and 14 of the '565 patent (reproduced below) depict PDC used in rotary drill bit **800**. 22:66-23:1, 23:11-12. In those figures, a plurality of PDCs **812** are affixed to blades **804**, which are affixed to the drill bit body **802**, as shown below. *Id.* at 23:21-24.

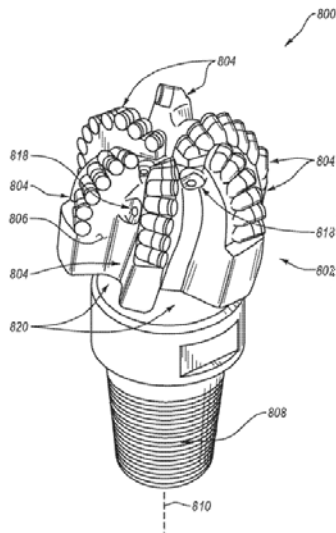

FIG. 13

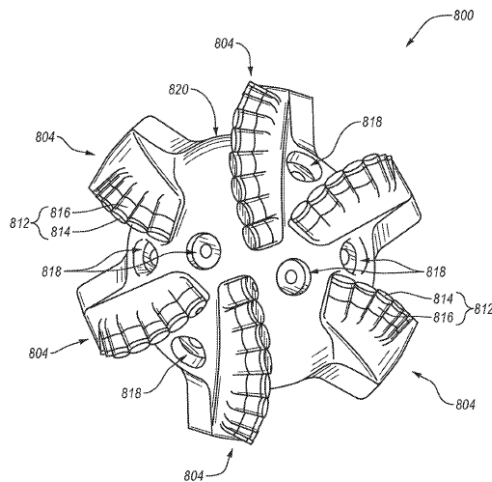

FIG. 14

The process of making a PDC, including synthesizing the diamond table, requires intense pressure and temperature to fuse or “sinter” the diamond grains to each other. *Id.* at 13:53-62. The pressure and temperature also help bond the diamond table to the substrate. Tr. (Bertagnolli), 60:7-18.

The patents explain that conventional PDCs were fabricated by placing the substrate into a cartridge with a volume of diamond particles next to the substrate. JX-0002 at 1:42-46. The cartridge is then loaded into a press that creates high-pressure and high-temperature conditions. *Id.* at 1:45-46. Cobalt from the substrate liquefies during the process and sweeps into interstitial

## PUBLIC VERSION

regions between the diamond particles. *Id.* at 55-60. The substrate and diamond particles are processed under those conditions in the presence of the cobalt, or other metal catalyst, that causes the diamond particles to bond to one another, creating a polycrystalline diamond table that is bonded to the substrate. *Id.* at 1:46-62, 9:28-32.

The conventional approach is described as having drawbacks. JX-0002 at 1:66-2:19. Having metal catalyst in the diamond matrix is helpful during the sintering process to promote diamond growth, but the metal catalyst can be detrimental to diamond table performance when the PDC is later used for drilling. *Id.*; Tr. (Bertagnolli), 71:19-72:10. One method for addressing the performance issues caused by having the metal catalyst in the diamond matrix is called “leaching.” *Id.*, 71:17-72:10. Leaching involves submerging the diamond table into an acid bath, which removes some of the metal catalyst. JX-0002 at 2:13-15; *see also* ’502 patent (JX-0003) at 12:20-47.

USS sought to create an improved type of PDC by reducing the amount of metal catalyst (*e.g.*, cobalt) and increasing the diamond bonding, but without requiring a leaching process to do so. USS Pet. at 7 (citing Tr. (Bertagnolli), 71:10-72:10). USS alleges it developed a way to exert higher sintering pressure. USS Pet. at 7 (citing CX-2349). These manufacturing methods led to the improved PDC described in the asserted patents with more diamond bonding and less cobalt. JX-0002 at 7:53-61.

The specifications teach that PDCs sintered at a pressure of at least about 7.5 GPa differ from conventional high-pressure and high-temperature products because they have “enhanced” or a “high-degree” of diamond-to-diamond bonding as a result of “increased nucleation and growth of diamond between the diamond particles.” *Id.* at 2:27-28, 4:34-49, 4:58-65, 7:53-61. Increasing the amount of diamond bonding reduces the size of the interstitial regions occupied

PUBLIC VERSION

by a metal-solvent catalyst and thereby affects the balance of metal-solvent catalyst to diamond grain in a PCD. *Id.* at 4:41-45; 7:53-61.

The specifications disclose that the improved PDC exhibits improved mechanical and/or thermal properties and performs better in high-abrasion applications, such as earth-boring drill bits. *See ID* at 8; JX-0002 at 5:28-31, 6:63-7:39. Good PDC performance reduces how frequently drill operators must remove or replace the drill bit. *See ID* at 8.

USS obtained patents containing various types of claims to its invention. USS Pet. at 11. Some claims, not at issue here, claimed the improved process of making the PDC. *Id.* The claims at issue in this investigation address the improved PDC itself.

The parties focus on limitations in claim 1 of the '565 patent and claims 1 and 15 of the '502 patent. Claim 1 of the '565 patent recites:

1. A polycrystalline diamond compact, comprising:

a polycrystalline diamond table, at least an unleached portion of the polycrystalline diamond table including:

a plurality of diamond grains directly bonded together via diamond-to-diamond bonding to define interstitial regions, the plurality of diamond grains exhibiting an average grain size of about 50  $\mu\text{m}$  or less;

a catalyst occupying at least a portion of the interstitial regions;

wherein the unleached portion of the polycrystalline diamond table exhibits a coercivity of about 115 Oe or more;

wherein the unleached portion of the polycrystalline diamond table exhibits an average electrical conductivity of less than about 1200 S/m; and

wherein the unleached portion of the polycrystalline diamond table exhibits a  $G_{\text{ratio}}$  of at least about  $4.0 \times 10^6$ ; and

a substrate bonded to the polycrystalline diamond table.

PUBLIC VERSION

Claims 1 and 15 of the '502 patent recite:

1. A polycrystalline diamond compact, comprising:

a polycrystalline diamond table, at least an unleached portion of the polycrystalline diamond table including:

a plurality of diamond grains bonded together via diamond-to-diamond bonding to define interstitial regions, the plurality of diamond grains exhibiting an average grain size of about 50  $\mu\text{m}$  or less; and

a catalyst including cobalt, the catalyst occupying at least a portion of the interstitial regions;

wherein the unleached portion of the polycrystalline diamond table exhibits a coercivity of about 115 Oe to about 250 Oe;

wherein the unleached portion of the polycrystalline diamond table exhibits a specific permeability less than about  $0.10 \text{ G}\cdot\text{cm}^3/\text{g}\cdot\text{Oe}$ ; and

a substrate bonded to the polycrystalline diamond table along an interfacial surface, the interfacial surface exhibiting a substantially planar topography;

wherein a lateral dimension of the polycrystalline diamond table is about 0.8 cm to about 1.9 cm.

15. A polycrystalline diamond compact, comprising:

a polycrystalline diamond table, at least an unleached portion of the polycrystalline diamond table including:

a plurality of diamond grains bonded together via diamond-to-diamond bonding to define defining interstitial regions, the plurality of diamond grains exhibiting an average grain size of about 50  $\mu\text{m}$  or less; and

a catalyst including cobalt, the catalyst occupying at least a portion of the interstitial regions;

wherein the unleached portion of the polycrystalline diamond table exhibits:

a coercivity of about 115 Oe to about 250 Oe;

a specific magnetic saturation of about  $10 \text{ G}\cdot\text{cm}^3/\text{g}$  to about  $15 \text{ G}\cdot\text{cm}^3/\text{g}$ ; and

PUBLIC VERSION

a thermal stability, as determined by a distance cut, prior to failure in a vertical lathe test, of about 1300 m to about 3950 m; wherein a lateral dimension of the polycrystalline diamond table is about 0.8 cm or more.

As can be seen in the claim language above, to define the improved PDC, the asserted claims require certain properties for the PDC set forth in numerical thresholds. The intrinsic evidence indicates that the properties reflect the structure of the PDC.

Specifically, the “average grain size” refers to an average size of diamond grains. *See* JX-0002 at 5:8-18. In addition, the asserted claims recite numerical thresholds for magnetic and electrical properties of the PCD. The claimed magnetic and electrical properties are coercivity,<sup>3</sup> electrical conductivity,<sup>4</sup> specific magnetic saturation,<sup>5</sup> and specific permeability.<sup>6</sup>

The specification of the ’502 patent teaches that coercivity, specific magnetic saturation, and specific permeability reflect the extent to which the diamond grains have bonded and formed large diamond grains thereby displacing the metal catalyst in the diamond matrix. *See*,

<sup>3</sup> Coercivity is the measurement of the magnetizing force required to return the magnetizing of PCD back to zero. *See* Order No. 23, at 27. Coercivity may be correlated with the average distance or “mean free path” between neighboring diamond grains of the PCD. JX-0002 at 5:40-49, 5:61-6:3. Thus, coercivity reflects how tightly the diamond grains are bonded together. *Id.*

<sup>4</sup> Electrical conductivity measures how conductive a PCD is, which is associated with both the amount of metal-solvent catalyst in the diamond microstructure and the continuity of the catalyst mesh between the diamond grains. JX-0002 at 4:41-49, 9:32-34. A PCD having a higher degree of diamond-to-diamond bonding has more pinched-off metal catalyst pathways and thus exhibits a lower average electrical conductivity. *Id.* at 4:41-49, 5:61-6:3, 7:53-8:5, 9:32-34, 9:63-10:3.

<sup>5</sup> Specific magnetic saturation represents a state in which an increase in the magnetizing force does not result in an increase in the magnetization of the material. *See* Order No. 23, at 29-30. Specific magnetic saturation is correlated with the amount of the metal-solvent catalyst in the PCD. JX-0002 at 5:35-39, 5:49-51.

<sup>6</sup> Specific permeability measures the ratio of specific magnetic saturation to coercivity. *See* JX-0002 at 4:47-49; Order No. 23, at 29.



## PUBLIC VERSION

*e.g.*, '502 patent (JX-0003) at 3:65-4:12, 4:58-5:7. The specification of the '565 patent provides a similar disclosure regarding those properties but further teaches that electrical conductivity also reflects the extent to which the diamond grains have bonded and displaced the metal catalyst. *See, e.g.*, JX-0002 at 4:34-54, 5:32-39, 22:44-47 (“Sensitivity of electrical conductivity measurements of PDC diamond tables of a given PCD microstructure may provide an excellent method for estimation and imaging of metal content in the diamond table.”).<sup>7</sup>

Asserted claims such as claim 1 of the '565 patent and claim 15 of the '502 patent also require that the PDC satisfy specific parameters that are used for measuring cutting performance. The claimed performance parameters are G-ratio<sup>8</sup> and thermal stability.<sup>9</sup> The specifications correlate the increased cutting performance with the improved microstructure. *See, e.g.*, JX-0003 at 4:54-57 (“By maintaining the metal-solvent catalyst content below about 7.5 wt %, the PCD may exhibit a desirable thermal stability suitable for subterranean drilling applications.”), 5:63-6:38; *see also* JX-0002 at 22:51-62 (“In fact, relatively lowered metal-solvent content in the PDC appears to substantially influence cutting performance. Therefore, it follows that the

<sup>7</sup> The specifications connect the claimed numerical thresholds for the magnetic and electrical properties to the improved process of making the PDC using a higher sintering pressure. *See* Table 1 of both patents (magnetic properties); JX-0002 at 4:58-64 (electrical conductivity).

<sup>8</sup> G-ratio is a measure of wear resistance that uses a vertical turret lathe (VTL) test to replicate drilling conditions by grinding the PDC against a large, rotating rock cylinder using a coolant. *Tr. (Bertagnolli)* at 75:17-77:22; *Tr. (German)* at 141:25-142:5; 7:13-14. It is measured as the ratio of the volume of workpiece cut to the volume of PCD worn away during a cutting process. JX-0002 at 7:2-5.

<sup>9</sup> Thermal Stability is a “dry VTL” measurement since it does not use a coolant. *Tr. (German)* at 158:24-159:12; JX-0003 at 6:14-38. It is “evaluated by measuring the distance cut in a workpiece prior to catastrophic failure, without using coolant, in a vertical lathe test (*e.g.*, vertical turret lathe or a vertical boring mill).” JX-0002 at 7:24-28.

## PUBLIC VERSION

electrical conductivity, also dependent on metal-solvent catalyst content, may also be used as a quality characteristic for evaluating PDC cutting performance.”).

In short, both patents describe a problem solved by the inventors as providing an improved PDC. The invention, meanwhile, is described in terms reflecting its structure, including its microstructure quantified by various measurements (*e.g.*, grain size, coercivity, magnetic saturation).

## II. THE ID’S SECTION 101 FINDINGS

The ID’s analysis focused on the ’565 patent and found the asserted claims of both the ’565 patent and ’502 patent ineligible under section 101 for the same reasons. At the first step of the two-part eligibility test, the ID observed the asserted claims of the ’565 patent “recite compositions of matter that are not found in nature.” ID at 102. The ID then continued by grouping claim features of the ’565 patent into categories and considering whether those categories are directed to a “result or effect.”

Specifically, the ID observed that the claims recite “certain structural and design features (for example, a particular grain size and a catalyst), performance measures (G-Ratio in claim 1 and its dependent claims and thermal stability in claim 18), and side effects (the various electrical and magnetic parameters).” *Id.* at 104; *see also id.* at 100. The ID found the structural and design features are “not problematic” under *Alice* but the performance measure and side effects “are problematic.” ID at 104-105. The ID explained that the performance measures are problematic because they “incorporate the goal or result of a particular measure of wear resistance (*i.e.*, G-Ratio) or thermal resilience (*i.e.*, thermal stability), however achieved.” *Id.* at 105. The ID explained that the side effect features (*i.e.*, the various electrical and magnetic parameters) are problematic because they are “an indirect measure of the effectiveness of other design choices and manufacturing variables” and “imperfect proxies for unclaimed features.” *Id.*

PUBLIC VERSION

at 103, 105. The ID also explained: “A low electrical conductivity is not a desirable feature as such; it is just a result of other desirable features.” *Id.* at 103.

The ID found that the claims of the ’565 and ’502 patents also fail *Alice* step two because they “invoke[] well-understood, routine, [and] conventional components to apply the abstract idea[s]” recited in the claims. *Id.* at 110.

On review, the Majority affirms the ID and clarifies the identification of the abstract idea. The Majority finds that the asserted claims are directed to the abstract idea of “PDCs that achieve the claimed performance measures and desired magnetic and electrical results, which the specifications claim are derived from enhanced diamond-to-diamond bonding.”

For the reasons explained below, I dissent from the Commission’s decision to affirm the ID’s section 101 determination.

### III. DISCUSSION

#### A. Patent-Eligibility under Section 101

Section 101 of the Patent Act defines the subject matter eligible for patent protection. It provides:

Whoever invents or discovers any new and useful process, machine, manufacture, or composition of matter, or any new and useful improvement thereof, may obtain a patent therefor, subject to the conditions and requirements of this title.

35 U.S.C. § 101. It has long been established that the expansive language of § 101 provides a broad scope for patent eligibility. *See Diamond v. Chakrabarty*, 447 U.S. 303, 308 (1980).

Within § 101’s expansive language, the Supreme Court has recognized “an important implicit exception: Laws of nature, natural phenomena, and abstract ideas are not patentable.” *Ass’n for Molecular Pathology v. Myriad Genetics, Inc.*, 569 U.S. 576, 589 (2013). The Court has described the concern that drives this exclusionary principle as one of pre-emption. “Laws

## PUBLIC VERSION

of nature, natural phenomena, and abstract ideas are . . . the basic tools of scientific and technological work.” *Id.* “[M]onopolization of those tools through the grant of a patent might tend to impede innovation more than it would tend to promote it,” thereby thwarting the primary object of the patent laws. *Mayo Collaborative Servs. v. Prometheus Labs., Inc.*, 566 U.S. 66, 71 (2012).

At the same time, the Court has cautioned lower tribunals to “tread carefully in construing this exclusionary principle lest it swallow all of patent law.” *Alice Corp. Pty. Ltd. v. CLS Bank Int’l*, 573 U.S. 208, 217 (2014). At some level, “all inventions . . . embody, use, reflect, rest upon, or apply laws of nature, natural phenomena, or abstract ideas.” *Id.* Thus, an invention is not rendered ineligible for patent protection simply because it involves an abstract concept. *Id.* (citing *Diamond v. Diehr*, 450 U.S. 175, 187 (1981)). “[A]pplication[s]’ of such concepts ‘to a new and useful end’ . . . remain eligible for patent protection.” *Alice*, 573 U.S. at 217 (citing *Gottschalk v. Benson*, 409 U.S. 63, 67 (1972)).

With these concerns in mind, Supreme Court precedent articulates a two-step framework for distinguishing patents that claim laws of nature, natural phenomena, or abstract ideas from those that claim patent-eligible applications of those concepts. *First*, a court must “determine whether the claims at issue are directed to [a] patent-ineligible concept[.]” *Alice*, 573 U.S. at 217. *Second*, if the claims are directed to a patent-ineligible concept, the court must then determine whether there are additional elements of the claim that contain an “inventive concept” sufficient to “transform” the claimed matter into a patent-eligible application. *Id.* at 217-218.

### **B. Application of *Alice* Step One**

The ID’s step-one abstractness determination turns on grouping the claim features into categories and considering whether those individual categories are directed to a “result or effect.” As explained below, the “problematic” results and effects which the ID identifies (*i.e.*, the

## PUBLIC VERSION

measurements of PDC properties) are not the sort of results Federal Circuit caselaw has called into question. Rather, the specifications (and other record evidence) indicate that they are measurements that reflect structure of a composition of matter. When the claim elements are considered as whole, I do not believe that any of the asserted claims are directed to an abstract idea.

### 1. The Asserted Claims Are Directed To A Composition of Matter

One only need to look at the language of the claims to observe that they are directed to measurable composition of matter for which eligibility should be routine. The claims recite, *inter alia*, a “polycrystalline diamond compact” comprising a “polycrystalline diamond table” with a “catalyst occupying at least a portion of the interstitial regions” wherein an “unleached portion” of the table includes certain measurable properties. All of the asserted claims recite specific ranges of average diamond “grain size” and measurable magnetic properties related to the diamond structure. Asserted claims also include specific ranges for “average electrical conductivity,” “G-Ratio” (*e.g.*, at least about  $4.0 \times 10^6$ ), “thermal stability” (*e.g.*, at least of about 1300 m), and the “lateral dimension of the polycrystalline diamond table.”

The specifications provide further insight into the nature of the claims. The specifications describe “nucleation and growth” of diamond between diamond particles during the sintering process, which impacts the structure of the PCD at the microscopic level by forming big diamond grains that pinch-off cobalt between diamond particles. JX-0002 at 7:53-61. The specifications disclose that the claimed average grain size is a structural threshold with the size being 50  $\mu\text{m}$  or less, or 30  $\mu\text{m}$  or less. *See id.* at 5:8-18. The specifications further disclose that the claimed magnetic and electrical properties reflect the microstructure of the PCD. *See, e.g.*, JX-0003 at 3:65-4:12 (embodiments exhibit enhanced diamond-to-diamond bonding and the magnetic properties reflect nucleation and growth of diamond particles); JX-0003 at 5:22-27

## PUBLIC VERSION

(“The PCD defined collectively by the bonded diamond grains and the metal-solvent catalyst may exhibit . . . a coercivity of about 115 Oe or more and a metal-solvent catalyst content of less than about 7.5 wt % as indicated by a specific magnetic saturation of about  $15 \text{ G}\cdot\text{cm}^3/\text{g}$  or less.”); JX-0002 at 5:32-39 (“Many physical characteristics of the PCD may be determined by measuring certain magnetic and electrical properties of the PCD because the metal-solvent catalyst may be ferromagnetic.”); JX-0002 at 22:44-47 (“Sensitivity of electrical conductivity measurements of PDC diamond tables of a given PCD microstructure may provide an excellent method for estimation and imaging of metal content in the diamond table.”).

For example, as the specifications explain, measured coercivity is a corollary of “[t]he mean free path between neighboring diamond grains,” which in turn is “indicative of the extent of diamond-to-diamond bonding.” JX-0002 at 5:40-48. Similarly, specific magnetic saturation is indicative of “the amount of the metal-solvent catalyst present.” *Id.* at 5:35-39. Electrical conductivity as disclosed in the ’565 patent measures how conductive a PCD is, which is associated with both the amount of metal-solvent catalyst in the diamond microstructure and the continuity of the catalyst mesh between the diamond grains. *Id.* at 4:41-49, 5:64-6:3, 9:32-34, 15:26-31.

The specifications further disclose that the improved PCD results in increased cutting performance, which is measured by G-ratio and thermal stability. *See, e.g.*, JX-0003 at 4:54-57, 5:63-6:38; *see also* JX-0002, 4:1-4, 15:49-61, 22:51-62. The specifications associate the claimed G-ratio and thermal stability measurements with the PCD microstructure. *Id.*

Thus, it is undisputed that the specifications associate the claimed properties with the PCD structure. In fact, the Majority agrees that “[a]s for the electrical and magnetic properties of a PCD, there is no dispute that the presence of cobalt or other metal-solvent catalyst in the PCD

## PUBLIC VERSION

is measurable.” However, the Majority does not explain their conclusion that the claimed properties do not define a “specific microstructure.” That conclusion seems inconsistent with the intrinsic evidence and the Majority’s concession that the electrical and magnetic properties reflect the presence of cobalt or other metal-solvent catalyst in the PCD.<sup>10</sup>

Labeling certain claim elements merely as “performance standards,” “results,” “side effects,” or “not a design choice,” in my view, fails to appreciate that the claimed parameters are concrete, objective measurements for defining the invention and which reflect the diamond microstructure. Many properties of patented materials could be described the same way. As is often the case in materials science and chemistry, intrinsic properties like density, pH, conductivity, and melting point result from other design choices, such as the choice of chemical inputs, processing parameters, and finishing steps. The claimed PDC involves a composition of matter that the inventors characterized based on *what it is*. That a particular material property of this composition of matter “results” from other design choices does not render it abstract.<sup>11</sup>

## **2. The Precedent Cited By Majority Does Not Support Finding The Claims Ineligible As Directed To An Abstract Idea**

Given that the abstract idea exception is a narrow, court-made exception to the language of § 101, we should tread carefully before extending the exception beyond the subject matter that the courts themselves have identified as being abstract. A manufactured composition of matter is

<sup>10</sup> Similarly, the Majority’s analysis under *Alice* step 2 finding the claimed properties to be “results-oriented” and “conventional” rests on the same conclusion. If the properties reflect structure, they are not results-oriented or conventional claim elements.

<sup>11</sup> The Majority cites USS’s expert testimony where he agreed the claimed properties are the result of the sintering conditions and input materials that went into manufacturing the PDC. *See* Tr. (German) at 1338:24-1339:4. The testimony is not inconsistent with the intrinsic evidence that those properties reflect the structure of the PDC. The idea that properties of a material may result from manufacturing conditions is unremarkable.

## PUBLIC VERSION

a class of invention that has historically been patent eligible. *See, e.g., Chakrabarty*, 447 U.S. at 308-09 (explaining that the Patent Act of 1793 defined statutory subject matter as “any new and useful art, machine, manufacture, or composition of matter, or any new or useful improvement [thereof]”); *Diehr*, 450 U.S. at 184 n.8 (observing that “[i]ndustrial processes” and “new machines and new compositions of matter” have “historically been eligible to receive the protection of our patent laws”); *see also Nat. Alternatives Int’l, Inc. v. Creative Compounds, LLC*, 918 F.3d 1338, 1347-49 (Fed. Cir. 2019) (holding product claims to dietary supplement to be eligible). The ID and Majority have identified no case, nor do the Respondents cite any, where a claim to a composition of matter has been deemed ineligible as an abstract idea.

The ID and Majority cite as support several Federal Circuit decisions involving claims for processing information using software on generic computer components – the “familiar class of claims” that often receive eligibility scrutiny under the *Alice* line of cases.<sup>12</sup> *See Elec. Power Group LLC v. Alstom S.A.*, 830 F.3d 1350, 1353 (Fed. Cir. 2016). I believe the reliance on those cases is misplaced. The “results” or “effects” which the Majority identifies (*i.e.*, the measurement of PDC properties) as problematic are *not* the sort of results that have been called into question in the software functionality computer cases.

Rather, those cases stand for the principle that “information as such is an intangible,” and

<sup>12</sup> The generic computer functionality cases cited by the ID and Majority include: *Apple, Inc. v. Ameranth, Inc.*, 842 F.3d 1229 (Fed. Cir. 2016) (claims related to software for information management and the result of generating menus on a display); *Free Stream Media Corp. v. Alphonso Inc.*, 996 F.3d 1355 (Fed. Cir. 2021) (claims related to software for gathering information and providing the result of target advertisements to a mobile device user); *Elec. Power Group LLC v. Alstom S.A.*, 830 F.3d 1350 (Fed. Cir. 2016) (claims related to software for monitoring an electrical grid); *Interval Licensing LLC v. AOL, Inc.*, 896 F.3d 1335 (Fed. Cir. 2018) (claims related to software for information acquisition, organization, and display); *Yu v. Apple Inc.*, 1 F.4<sup>th</sup> 1040 (Fed. Cir. 2021) (claims related to processing information to produce a digital image); *ChargePoint, Inc. v. SemaConnect, Inc.*, 920 F.3d 759 (Fed. Cir. 2019) (claims related to functionality of communicating over a generic network).



## PUBLIC VERSION

hence abstract. *Id.*; *SAP America, Inc. v. Investpic, LLC*, 898 F.3d 1161, 1167 (Fed. Cir. 2018). Therefore, “merely presenting the *results* of abstract processes of collecting and analyzing information, without more . . . is abstract.” *Elec. Power Group*, 830 F.3d at 1354 (emphasis added). As the Federal Circuit has explained, ineligible patents “claiming only a result” of an abstract process and which lack specificity must be “contrast[ed]” with eligible patents claiming “physical-realm improvements.” *SAP America*, 898 F.3d at 1167. The claimed PDC is a “physical-realm” improvement defined by specific, measurable parameters.

The Majority opinion cites *Alice* and *Yu v. Apple Inc.*, 1 F.4<sup>th</sup> 1040 (Fed. Cir. 2021), to argue that the fact that asserted claims involve physical phenomena is “beside the point.” Specifically, the quote from *Alice* cited by the Majority includes the statement that “[t]he fact that a computer ‘necessarily exist[s] in the physical, rather than purely conceptual, realm,’ is beside the point.” 573 U.S. at 224. That statement merely stands for the common-sense proposition that the claimed methods are not patent eligible just because they operate in the tangible world. This makes sense because generic computers used to perform software functionality steps are tangible objects. But taking *Alice*’s unremarkable statement and applying it to the improved composition of matter at issue here to find it abstract is not supported by the decision.

*Yu v. Apple* is similar to *Alice* and the other cases involving abstract steps performed on generic computer components. The claim at issue in *Yu* involved computing functions – *i.e.*, processing information using conventional components of a digital camera. It is true that the conventional digital camera components operate in the tangible world just like the generic computer referenced in *Alice*. But, similar to the point above with *Alice*, that does not support finding the improved PDC to be abstract.

## PUBLIC VERSION

The Majority opinion’s reliance on *American Axle & Mfg., Inc. v. Neapco Holdings LLC*, 967 F.3d 1285, 1302 (Fed. Cir. 2020), is also misplaced. In *American Axle*, the claims at issue recited a manufacturing method directed to the “result” of applying a law of nature – Hooke’s law. The inventor’s own deposition testimony confirmed that the claimed “tuning” element of the method claim merely required the use of Hooke’s law. *Id.* at 1294. There was no structural claim at issue nor any specific numerical range to limit the application of Hooke’s law. *Id.* at 1295. Notably, the Federal Circuit explained that “[w]hat is missing is any physical structure or steps for achieving the claimed result” of applying natural law. Here, in contrast, the advance of the claimed invention is a *physical structure* described by various measured parameters.<sup>13</sup>

The Majority also relies on the Supreme Court decision in *O’Reilly v. Morse*, 56 U.S. (15 How.) 62 (1853). The claim held ineligible in *O’Reilly* is distinguishable on its face to those at issue in this investigation. The claim in *O’Reilly* was not limited to any particular machinery or other structure and was instead broadly directed to the use of electromagnetism, “however developed,” for transmitting information. *Id.* at 112.

The Majority additionally cites as support the Supreme Court decision in *Funk Brothers Seed Co. v. Kalo Inoculant Co.*, 333 U.S. 127 (1948). *Funk Brothers* addressed the eligibility of claims directed to a natural phenomenon, *i.e.*, a mixture of naturally occurring strains of bacteria. *Id.* at 128–30. The Court concluded that this mixture of bacteria strains was not patent eligible because the patentee did not alter the bacteria in any way. *Id.* at 132. In the current investigation, there is no dispute that the asserted claims recite compositions of matter that are

<sup>13</sup> *American Axle* instructs that product claims should be limited to structures specified at some level of concreteness. 967 F.3d at 1302. The parameters recited in the claims, which are objective and measurable, specify structure in a concrete way. *See, e.g.* JX-0002 at 5:32-39; Tr. (German) at 1243:12-23.

## PUBLIC VERSION

*not* found in nature. ID at 102. Thus, Respondents are not arguing, the Majority does not find, that the asserted claims are directed to a natural phenomenon. Although the claimed bacteria in *Funk Brothers* were naturally occurring organisms, they were certainly not abstract ideas. In my view, *Funk Brothers* does not support finding the claims at issue here are directed to an abstract idea.<sup>14</sup>

Unlike the Majority opinion, I do not see there being any preemption concerns.

*ChargePoint, Inc. v. SemaConnect, Inc.*, cited by the Majority, involved claims related to generic network communication functionality applied to any electric vehicle charging station. In finding the claims directed to an abstract idea, the Court explained that communication over a network is a “building block of the modern economy” and that claim 1 would broadly “preempt the use of any networked charging stations.” 920 F.3d at 769, 773.

In contrast to *ChargePoint*, there is no evidence that the asserted claims would broadly preempt all PDCs. In fact, the evidence indicates that PDC manufacturers are capable of manufacturing PDCs that do not read on the asserted claims. For example, during the pendency of this investigation, SF Diamond developed A-Series redesign products, which the ID found to

<sup>14</sup> I also do not believe that *Le Roy v. Tatham*, 55 U.S. 156 (1852), supports the Majority’s decision today. *Le Roy* found the claim at issue eligible. *Le Roy* stands for the proposition that an application of a law of nature to a new and useful end may be deserving of patent protection.

Further, *Certain Light-Emitting Diode Products, Fixtures, and Components Thereof*, Inv. No. 337-TA-1213, cited by the ID and Majority is also distinguishable. There, the claim was directed to energy efficiency of lighting devices having a wall plug efficiency of at least 85 lumens/watt “however achieved.” Final ID at 22 (Aug. 25, 2021), *aff’d* by Comm’n Op. (Jan. 14, 2022). The asserted claim recited only one structure, and only in the most generic terms: a “solid state light emitter.” Final ID at 22. It was indisputably a conventional component performing conventional function of producing light when supplied with electricity. *Id.* at 25. In contrast, in the current investigation the asserted claims are structurally defined with concrete, measurable parameters.

## PUBLIC VERSION

be non-infringing. *See* ID at 39-43, 55, 68, 160. Further, the specifications disclose polycrystalline diamond in Tables II-III that have magnetic properties outside the claimed ranges. *See, e.g.,* JX-0002 at tbls.II-III.<sup>15</sup>

The Majority opinion criticizes the patentee for not incorporating manufacturing steps or equipment into the asserted claims. However, it is well-understood that product claims, unlike product-by-process claims, do not need to recite a method of achieving the claimed product. *See Vanguard Prods. Corp. v. Parker Hannifin Corp.*, 234 F.3d 1370, 1372 (Fed. Cir. 2000) (“The method of manufacture, even when cited as advantageous, does not of itself convert product claims into claims limited to a particular process.”). The Patent Act includes provisions for challenging eligible patent claims drafted in an overly broad fashion (section 112), that lack novelty (section 102), and that involve the combination of familiar elements according to known methods yielding predictable results (section 103). *See Diehr*, 450 U.S. at 188-90 (“The question therefore of whether a particular invention is novel is wholly apart from whether the invention falls into a category of statutory subject matter.”); *Data Engine Techs. LLC v. Google LLC*, 906 F.3d 999, 1011 (Fed. Cir. 2018) (“The eligibility question is not whether anyone has ever used tabs to organize information. That question is reserved for §§ 102 and 103.”).

The outcome in this case – finding claims reciting a specific, definable composition of

<sup>15</sup> As support for preemption, the Majority opinion identifies two infringing products that it finds were sintered at a pressure less than 7.5 GPa. Whether *two* infringing PDC products practice an unclaimed cell pressure parameter – especially when the record demonstrates that there are non-infringing PDCs available – does not in my view demonstrate monopolizing a “building block” of the economy or “basic tools of scientific and technological work.” *See Alice*, 573 U.S. at 216-217; *compare* CX-0383C (listing all tested products), with ID at 10-11 (listing only the accused products). If claims do not preempt a “building block” of human ingenuity or “basic tools of scientific and technological work,” then breadth of claiming is addressed by other statutory provisions. *See infra*.

PUBLIC VERSION

matter as ineligible – suggests that the ID and Majority have strayed from the preemption concerns that motivate the judicial exception to patent eligibility. The claims at issue here are far removed from the concern expressed in *Alice* whereby a claim states an abstract idea while adding the words “apply it with a computer.” 573 U.S. at 223.

For all the reasons explained above, I find that the asserted claims are not directed to an abstract idea, but instead to eligible subject matter. Because I believe the claims are not directed to an abstract idea, there is no need to proceed to *Alice* step two.

Because that I would reverse the ID’s section 101 findings, I would also reverse the ID’s finding of no violation in this investigation for the asserted claims that were not otherwise found invalid under section 102.<sup>16</sup> Specifically, I would find a violation based on infringement of claims 1, 2, 11, 15, and 21 of the ’502 patent.

---

<sup>16</sup> I would affirm the ID’s conclusion that USS established the economic prong of the domestic industry requirement for the ’565 patent and the ’502 patent under subsections (A), (B), and (C) of 337(a)(3). I would, however, not adopt all of the ID’s subsidiary findings on the economic prong, such as ID’s findings excluding administrative overhead investments and costs associated with “indirect labor.” *See* ID at 147, 152.